



# PRODUCT DATA

Index on inside back cover  
Form: PD-1016

# Non-Reflective Cloth/Gaffers Tapes...

## CGT-80... Gaffers/Spike Tape (low gloss finish)

11.8 mil (0.30mm). 76 mesh. High quality polyethylene-coated cloth laminated to a **low gloss** finish film, coated with a natural rubber based adhesive. Conforms well to irregular surfaces and will not twist or curl during application. Excellent water, vapor and abrasion resistance. Clean removal on most surfaces (surface type & dwell time may affect performance). Suitable for entertainment type applications (concerts, trade shows, etc.) where minimal visibility of tape is desired. Used for holding down cable, wires, electrical cords, and in stage set-ups for marking placement (i.e. "spike" tape). Suitable as a book binding tape for seaming & reinforcement. Peel Adhesion: 29 oz/in. Tensile Strength: 36 lb/in. Temperature Resistance: -31°F to 176°F. 3" neutral core/carton.

**11 COLORS AVAILABLE: Black\*, white\*, gray\*, red, yellow, dark blue, light blue, dark green, olive drab, brown\* & burgundy\*.**

**\*45 yd. is STOCKED in black, white, gray, brown & burgundy ONLY. Full case quantities ONLY (not sold by the roll).**

(Other colors available as special order; MOQ = 12 cases per color.)

## CGT-80MG... Military Grade Tape (low gloss finish)

12.2 mil (0.31mm). 76 mesh. Military grade, polyethylene-coated cloth with a low gloss finish, coated with a strong, natural rubber adhesive. Excellent abrasion and water resistance, as tape is composed of a water-resistant woven cloth and evenly coated with a pressure-sensitive water-insoluble adhesive. Conforms well to irregular surfaces. Clean removal on most surfaces. Tape has superior tensile strength, yet is hand-tearable. Used for packaging, box closure, and sealing, where water resistance is required. Peel Adhesion: 21 oz/in. Tensile Strength: 40 lb/in. Temperature Range: 41°F to 95°F. Meets MIL Specification ASTM D5486M, Type IV (supersedes PPP-T-60). 3" neutral core/carton.

**1 COLOR AVAILABLE: Olive drab\*.**

(\*Other colors available as special order; call for details/minimums.)

## CGT-665C... Gaffers/Spike Tape (matte finish)

11.5 mil (0.29mm). Non-reflective, vinyl-coated cotton cloth with a natural rubber/synthetic resin blend adhesive. Hand-tearable. High quality waterproof tape, matte surface finish. High tack and tensile strength. Highly conformable. Preferred for entertainment type applications (concerts, trade shows, etc.) where minimal visibility of tape is desired. Used for holding down cable, wires, electrical cords, and in stage set-ups for marking placement (i.e. "spike" tape). Used in the motion picture & television industries, and as a book-binding tape. Insures air tight, moisture free seals. Tensile Strength: 42 lb/in. Adhesion/Steel: 50 oz/in. Maximum Performance Temperature: 200°F. 3" neutral core/carton.

**5 COLORS AVAILABLE: Black, white, gray, red & yellow.**

**JUMBOS AVAILABLE.**

CASES

WIDTH	RLS/CS	CASES		
		1-5	6-11	12+
<b>45 YD - BLACK, WHITE, GRAY, BROWN &amp; BURGUNDY ONLY</b>				
2"	(48mm) 24			
3"	(72mm) 16			
49"	(1250mm) 2		same color	

60 YD (55M) 180 FT

1/2"	(12mm) 96			
3/4"	(18mm) 64			
1"	(24mm) 48			
1.5"	(36mm) 32			
2"	(48mm) 24			
2.5"	(60mm) 20			
3"	(72mm) 16			
4"	(96mm) 12			
6"	(144mm) 8			
12"	(288mm) 4			
12"	(304.8mm) 4			
49"	(1250mm) LOG			
49"	(1250mm) 2		same color	
49"	(1250mm) x 547 YD (500M) JUMBO			

Alternative to Shurtape #PC-625; Scapa #125.

60 yd. (only) is available by the roll @ 1-5 case price +10%.  
Minimum 6 inches per color.

60 YD (55M) 180 FT

1"	(24mm) 48			
1.5"	(36mm) 32			
<b>2"</b>	<b>(48mm) 24</b>			
3"	(72mm) 16			
4"	(96mm) 12			
6"	(144mm) 8			
49"	(1250mm) LOG			
49"	(1250mm) 2			

\* Lower proportional price, as stocked pre-slit.

Minimum 6 inches @ 1-5 case price +10%.

60 YD (55M) 180 FT

1/2"	(12mm) 96			
3/4"	(18mm) 64			
1"	(24mm) 48			
1.5"	(36mm) 32			
2"	(48mm) 24			
2.5"	(60mm) 20			
3"	(72mm) 16			
4"	(96mm) 12			
6"	(144mm) 8			
12"	(288mm) 4			
12"	(304.8mm) 4			
56"	(1422mm) LOG			
59.5"	(1510mm) LOG		(BLACK & WHITE ONLY)	

Alternative to Berry Global #510; Shurtape #P-628; Scapa #125 & 225; 3M #6910.

Minimum 6 inches per color @ 1-5 case price +10%.

# Cloth Duct Tapes...

## CDT-UG7/CDT-EG7... Utility Grade Duct Tape

50 mesh. Economy grade polyethylene-coated cloth with a natural rubber adhesive. Good tensile strength, hand tearable, excellent moisture resistance. Conforms well to irregular surfaces. Used for bundling, heavy carton sealing, general maintenance, pipe wrapping, carpet fixing, AC duct seaming and joint sealing. 3" neutral core.

<b>Physical Properties:</b>	<b>CDT-UG7</b>	<b>CDT-EG7</b>
Total Thickness	7.0 mils	7.2 mils
Adhesion to Steel	65 oz/in	44 oz/in
Tensile Strength	22 lbs/in	31 lbs/in
Elongation	19%	12%
Temperature Range	40°F to 200°F	-4°F to 140°F
Colors (Stocked)	<b>Silver (gray)</b>	<b>Silver (gray) &amp; Black</b>

*(Other colors available as special order)*

Alternative to Cantech #88-21 & #93-21; Nashua #307; Berry Global #917; IPG #AC10; Scapa #460 & #590.

## CDT-36... Industrial Grade Duct Tape

10.2 mil. 38 mesh. High quality general purpose polyethylene-coated cloth with a natural rubber based adhesive. Tape will conform well to irregular surfaces, and will not twist or curl during application. Excellent water and abrasion resistance. Tape is hand-tearable (tears evenly across web). Used as a quality waterproof packaging tape for export shipments; for splicing, vinyl repair, protecting, bundling, and color coding; for ductwork sealing and seaming. Peel Adhesion: 36 oz/in. Tensile Strength: 18 lbs/in. Temperature Range: -31°F to 176°F. 3" neutral core/carton.

**18 COLORS AVAILABLE: Silver (gray), black, white, yellow, schoolbus yellow (ochre), sky blue, teal blue, dark blue, pink, red, burgundy, purple, racing orange, tan (beige), brown, light green, dark green & olive drab.**

Alternative to Tesa #64662; IPG #AC30 & #AC36; 3M #9699; Scapa #248; Shurtape #PC-610 & #PC-620; Berry Global #223; Nashua #398.

## CDT-70... Contractor Grade Duct Tape

11.8 mil. 63 mesh. High tensile polyethylene-coated cloth with a natural rubber based adhesive. It is a superior performance duct tape specifically designed for the high demand of contractor applications. Product has excellent shear values to surface and backing. It has good conformability and excellent resistance to tear. Used in HVAC industry to provide an excellent seal for thermal insulation and air conditioning ducts; as a moisture barrier for both indoor and outdoor applications; asbestos abatement applications; quality waterproof packaging tape for export shipments; for splicing, vinyl repair, protecting, and bundling. Peel Adhesion: 36 oz/in. Tensile Strength: 30 lbs/in. Temperature Range: -31°F to 176°F. 3" neutral core/carton.

**4 COLORS AVAILABLE: Silver (gray), black, white & olive drab.**

## CDT-70HD... Heavy Duty Premium Duct Tape

16.9 mil. 70 mesh. High quality, high tensile polyethylene-coated cloth with a natural rubber based adhesive. Designed for the high demand contractor applications. Excellent shear values to surface and backing. Used as a quality waterproof packaging tape for export shipments; for splicing, vinyl repair, protecting, and bundling; for ductwork sealing and seaming. Peel Adhesion: 54 oz/in. Tensile Strength: 38 lbs/in. Temperature Resistance: 104°F (long term) to 176°F (short term). 3" neutral core/carton.

**1 COLOR AVAILABLE: Black.**

WIDTH	RLS/CS	CASES		
		1-5	6-11	12+
<b>CDT-UG7 60 YD (55M) 180 FT - SILVER ONLY</b>				
2"	* (48mm)	24		

\* Stocked pre-slit.

## CDT-EG7 60 YD (55M) 180 FT - SILVER & BLACK

1/2"	(12mm)	96
3/4"	(18mm)	64
1"	(24mm)	48
1.5"	(36mm)	32
2"	(48mm)	24
2.5"	(60mm)	20
3"	(72mm)	16
4"	(96mm)	12
6"	(144mm)	8
41.7"	(1060mm)	LOG
41.7"	(1060mm)	x 1200M JUMBO

Minimum 6 inches per color @ 1-5 case price +10%.

## 30 YD (27M) 90 FT - BLACK ONLY

2"	(48mm)	36
----	--------	----

## 60 YD (55M) 180 FT - ALL COLORS

1/2"	(12mm)	96
3/4"	(18mm)	64
1"	(24mm)	48
1.5"	(36mm)	32
2"	(48mm)	24
2.5"	(60mm)	20
3"	(72mm)	16
4"	(96mm)	12
5"	(120mm)	8
6"	(144mm)	8
12"	(288mm)	4
12"	(304.8mm)	4
49"	(1250mm)	LOG
49"	(1250mm)	2 same color

Minimum 6 inches per color @ 1-5 case price +10%.

## 60 YD (55M) 180 FT

1/2"	(12mm)	96
3/4"	(18mm)	64
1"	(24mm)	48
1.5"	(36mm)	32
2"	(48mm)	24
2.5"	(60mm)	20
3"	(72mm)	16
4"	(96mm)	12
6"	(144mm)	8
12"	(288mm)	4
49"	(1250mm)	LOG
49"	(1250mm)	2 same color
49"	(1250mm)	x 547 YD (500M) JUMBO

Alternative to Berry Global #227; IPG #AC43; Shurtape #PC621 & #PC-721; Ideal #469; Scapa #146; Tesa #64663; Achem #DT39.

Minimum 6 inches per color @ 1-5 case price +10%.

## 39.4 YD (36M) 118 FT - BLACK ONLY

2"	* (48mm)	24
----	----------	----

Alternative to Nashua #349; Shurtape #PC745.

\* Stocked pre-slit.

# Specialty Cloth Tapes...

## CDT-HS... Hazard/Striped Duct Tape

11.8 mil. 63 mesh. High quality polyethylene-coated cloth duct tape, with natural rubber with synthetic adhesive. This striped safety warning tape is used for permanent and temporary marking of hazardous areas, aisles, stairs, wires, cords, etc. Ideal for use in manufacturing, as well as in convention/exhibition halls, residential/commercial sites. Hand-tearable and easy to use. Peels off easily upon removal, leaving no residue on most surfaces. Peel Adhesion: 36 oz/in. Tensile: 30 lbs/in. Temperature Range: -31°F to 176°F. 3" neutral core/carton.

**COLOR: Black/yellow diagonal stripes.**

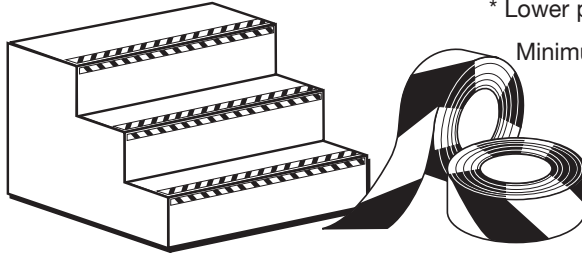

WIDTH	RLS/CS	CASES		
		1-5	6-11	12+
<b>60 YD (55M) 180 FT</b>				
1"	(24mm)	48		
1.5"	(36mm)	32		
2"	* (48mm)	24		
3"	* (72mm)	16		
4"	(96mm)	12		
6"	(144mm)	8		
49"	(1250mm)	LOG		
49"	(1250mm)	2		
49"	(1250mm)	x 500M JUMBO		

\* Lower proportional price, as stocked pre-slit.

Minimum 6 inches @ 1-5 case price +10%.

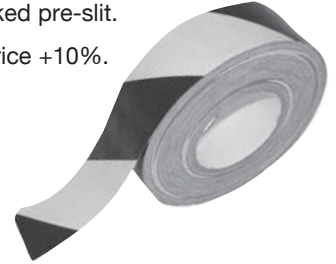

## CDT-80CAM... Camouflage Cloth Duct Tape

11.8 mil. 76 mesh. Polyethylene coated cloth with a natural rubber with synthetic resin adhesive; multi-colored. Peel Adhesion: 30 oz/in. Tensile Strength: 36 lb/in. Elongation: 11.5% Operating Temperature Range: 23°F to 95°F. Heat Resistance: 176°F (3 hrs max). 3" neutral core/carton.

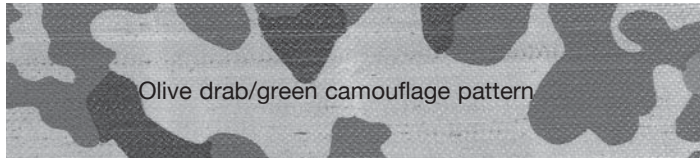

Olive drab/green camouflage pattern

<b>25 YD (23M) 75 FT</b>				
1"	(24mm)	48		
1.5"	(36mm)	32		
2"	(48mm)	24		
3"	(72mm)	16		
4"	(96mm)	12		
6"	(144mm)	8		
49"	(1250mm)	LOG		
49"	(1250mm)	2		
49"	(1250mm)	x 500M JUMBO		

Alternative to Shurtape #PC-625

Minimum 6 inches @ 1-5 case price +10%.

## CZT... CablZone Tape

CablZone Tape is used to manage cables, cords & wires and avoid accidental tripping & unplugging in warehouses, convention centers, theaters, etc. The center length on the adhesive side of the tape has a plastic coating ("dead zone") that creates an adhesive-free zone or channel for cables so they do not get gummy with adhesive residue. Removes cleanly from most surfaces. Hand-tearable.

Physical Properties	CZT-70B	CZT-70B/Y	CZT-80LBG	CZT-140MB
Backing	PE Coated Cloth			Cotton Cloth
Total Thickness	11.8 mil	11.8 mil	11.8 mil	12.8 mil
Adhesive Type	Natural Rubber			
Peel Adhesion	36 oz/in	36 oz/in	25 oz/in	32 oz/in
Tensile - Adhesive Area	29 lb/in	29 lb/in	36 lb/in	47 lb/in
Tensile - Dead Zone	36 lb/in	36 lb/in	40 lb/in	50 lb/in
Holding Power	20 min			60 min
Temperature Range	-31°F to 176°F			

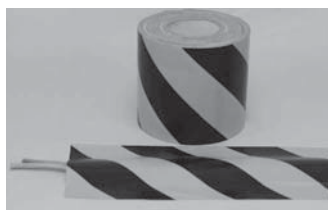

"Dead Zone" Widths  
 3"(75mm) = 40mm dead zone  
 4"(100mm) = 57mm dead zone  
 6"(150mm) = 80mm dead zone

WIDTH	RLS/CS	CASES		
		1-2	3-5	6+
<b>39.4YD (36M)</b>				
<b>CZT-70B (BLACK)</b>				
<b>70 MESH CLOTH DUCT TAPE - SHINY SURFACE</b>				
3"	(75mm)	16		

<b>CZT-70B/Y (BLACK/YELLOW)</b>				
<b>70 MESH CLOTH DUCT TAPE - SHINY SURFACE</b>				
3"	(75mm)	16		
4"	(100mm)	12		
6"	(150mm)	8		

<b>CZT-80LBG (BLACK)</b>				
<b>80 MESH CLOTH - LOW GLOSS SURFACE</b>				
3"	(75mm)	16		
4"	(100mm)	12		

<b>CZT-140MB (BLACK)</b>				
<b>140 MESH PREMIER GRADE - MATTE SURFACE</b>				
3"	(75mm)	16		

All CZT is available by the roll @ 1-5 case price +10%.

# Fluorescent Cloth Tapes...

## CDT-70F... Fluorescent Duct Tape

11.8 mil. High tensile, high quality fluorescent PE-coated cloth with a natural rubber/synthetic resin adhesive. Superior performance duct tape specifically designed for the high demand contractor applications. Easy tear and unwinding. Its water resistant adhesive system allows this product to bond to almost any surface, including porous surfaces. Used for night amusement industry such as night club, karaoke and music hall or show window that is used under black light. Adhesion/Steel: 35 oz/in. Tensile Strength: 33 lb/in. Temp. Resistance: -31°F to 106°F. 3" neutral core/carton.

**4 COLORS AVAILABLE: Fluorescent green, orange, pink & yellow.**



## CGT-80F... FL.Gaffers/Spike Tape (low gloss)

11.8 mil. High quality fluorescent PE-coated cloth laminated to a **low gloss** finish film, coated with a natural rubber adhesive. Suitable for entertainment type applications (concerts, trade shows, etc.); for holding down cable, wires, electrical cords, and marking stage placements (i.e. "spike" tape). Hand-tearable, conforms well to irregular surfaces, and will not twist or curl during application. Excellent water, vapor and abrasion resistance. Clean removal on most surfaces. Adhesion/Steel: >25 oz/in. Tensile Strength: >36 lb/in. Temp. Resistance: -31°F to 176°F. 3" neutral core/carton.

**4 COLORS AVAILABLE: Fluorescent green, orange, pink & yellow.**

## FCT-665... Fluorescent Gaffers/Spike Tape (matte finish)

11.5 mil. Heavy-duty fluorescent vinyl coated tape with a strong natural rubber adhesive. This product has a matte-finish for less reflectivity and low sheen. Used for wrapping or bundling wires, tools, and handles. Suitable for bookbinding and entertainment type applications (trade shows, photography, film industry) where minimal visibility of tape is desired. Allows for a clean removal, leaving no residue. Adhesion/Steel: 50 oz/in. Tensile Strength: 42 lb/in. Temp. Resistance: 40°F to 200°F. 3" neutral core/carton.

**4 COLORS AVAILABLE: Fluorescent green, orange, pink & yellow.**

# Friction Tapes...

## CFT-15...

13.3 mil. Black cotton cloth with non-corrosive rubber resin adhesive. Hand-tearable, extremely conformable, highly resistant to humidity and galvanic corrosion. Holds tightly on rough and irregular surfaces. Adhesive will not dry out. Used for insulation and to protect industrial harnesses and electrical wires from physical damage caused by friction, for over wrapping low voltage splices and general electrical maintenance jobs. Dielectric Strength: 1kV. Insulation Class: 176°F. Tensile Strength: 46 lbs/in. Elongation: 4%. Meets ASTM 4514-85. Individually cello-wrapped (no label) - 10 rolls per tube sleeve. 1 1/2" (38.1mm) neutral core.

## 4863RW... Mandrel Dimpled Roller Wrap

31.5 mil. Specially treated fabric covered with a gray embossed silicone rubber coating. Acrylic Adhesive. Highly resistant to "sticky" substances yet provides "non-slip" effect on smooth substrates. Used in adhesive tape manufacturing, general converting, printing, textiles, and paper/film industries. Adhesion to Steel: 48 oz/in. Temperature Resistance: Up to 176°F. Polypropylene liner. 3" neutral core.

WIDTH	RLS/CS	CASES		
		1-5	6-11	12+
<b>60 YD (55M) 180 FT</b>				
1/2"	(12mm)	96		
3/4"	(18mm)	64		
1"	(24mm)	48		
2"	(48mm)	24		
3"	(72mm)	16		
49"	(1250mm)	LOG		
49"	(1250mm)	x 500M JUMBO (FL YELLOW ONLY)		

Alternative to Vendor #PC619.

Minimum 6 inches per color @ 1-5 case price +10%.

<b>60 YD (55M) 180 FT</b>				
1/2"	(12mm)	96		
3/4"	(18mm)	64		
1"	(24mm)	48		
1.5"	(36mm)	32		
2"	(48mm)	24		
3"	(72mm)	16		
4"	(96mm)	12		
6"	(144mm)	8		
12"	(288mm)	4		
49"	(1250mm)	LOG		
49"	(1250mm)	2		
49"	(1250mm)	x 500M JUMBO		

Minimum 6 inches per color @ 1-5 case price +10%.

<b>60 YD (55M) 180 FT</b>				
1/2"	(12mm)	96		
3/4"	(18mm)	64		
1"	(24mm)	48		
1.5"	(36mm)	32		
2"	(48mm)	24		
3"	(72mm)	16		
57"	(1450mm)	LOG		
57"	(1450mm)	x 1200YD JUMBO		

Alternative to Berry Global #510; Permacel #660; Scapa #125FL; Shurtape #P-660.

Minimum 6 inches per color @ 1-5 case price +10%.

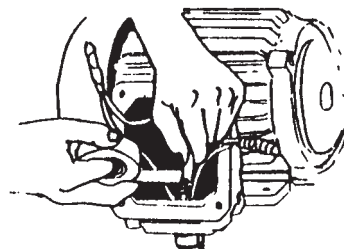

WIDTH x LENGTH	RLS/CS	COST PER ROLL
3/4" (18mm) x 60'	100	
1.5" (36mm) x 60'	50	
2" (48mm) x 60'	40	

WIDTH x LENGTH	RLS/CS	ROLL	CASE
2" (50mm) x 25M	2		

Alternative to Tesa #4863.



# Vinyl Electrical Insulating Tapes...

## EL760-B... COLORS

Same specs as EL7xx-B.

## EL7xx-B\* ... BLACK

7 mil (0.18mm) Electrical Insulation Tape. Plasticized PVC with rubber based adhesive. For wire and cable insulation, bundling, primary splice insulation at no more than 600V. Non-flame retardant. Adhesion: 14 oz/in. Dielectric Breakdown: 6KV. Tensile Strength: 16 lb/in. Elongation: 200%. Temp. Resistance: 176° F (80° C). Highlighted sizes are cello-wrapped (no label) - 10 rolls/tube sleeve. Other sizes are slit to order, and are bulk-packed, separated by silicone sheets. 1 1/2" (38.1mm) UL listed core.

\*xx = Length



## EL760AW-L... BLACK

Same specs as EL766AW-L.

## EL766AW-L... COLORS

**Flame retardant & cold resistant.** 7 mil (0.18mm). Plasticized PVC film with a rubber based adhesive in OSHA colors. For cable coding, quick identification of electrical phases, circuits, feeders and branches. Dielectrical Breakdown: 6KV. Tensile: 16lb/in. Adhesion: 13 oz/in. Elongation: 200%. Temp. Resistance: 176°F (80°C). Individually cello wrapped and labeled. 1 1/2" (38.1mm) UL/CSA listed core.

## EL766AWR-L... RAINBOW PACK

Same specs as EL766AW-L. Each subpack contains 10 different colors.

## EL766AW-B... COLORS

**Flame retardant & cold resistant.** 7 mil (0.18mm). Plasticized PVC film with a rubber based adhesive in OSHA colors. These special widths are slit to order, and are bulk packed, separated by silicone sheets. 1 1/2" (38.1mm) UL/CSA/CE listed core.

## EL7566AW-L... All Weather

**Flame Retardant & Cold Resistant** 8 mil (0.20mm) **Black** PVC premium grade electrical insulation tape with a rubber based adhesive. Dielectric Breakdown: 6KV. Adhesion: 14 oz/in. Tensile: 17 lbs/in. Elongation: 250%. Temp. Resistance: 176°F (80°C). Individually cello wrapped and labeled. 1 1/2" (38.1mm) UL/CSA listed core.

## EL7566AW-B... All Weather

**Flame Retardant & Cold Resistant** 8 mil (0.20mm) **Black** PVC premium grade electrical insulation tape with a rubber based adhesive. Dielectric Breakdown: 6KV. These special widths are slit to order, and are bulk packed, separated by silicone sheets. 1 1/2" (38.1mm) UL/CSA listed core.

UL/CSA/CE Listed

CASES

WIDTH x LENGTH RLS/CS 1-18 19-48 49+

3/4" (18mm) x 60'	200		
-------------------	-----	--	--

(7) COLORS AVAILABLE: Black, white, green, orange, red, blue & yellow.

3/8" (9mm) x 66'	264		
3/8" (9mm) x 108'	264		
1/2" (12mm) x 66'	192		
1/2" (12mm) x 108'	192		
3/4" * (19mm) x 30'	200		
3/4" (19mm) x 60'	100		
3/4" (19mm) x 66'	100		
3/4" (19mm) x 108'	100		
1" (24mm) x 66'	160		
1" (24mm) x 108'	96		
1.5" (36mm) x 66'	120		
1.5" (36mm) x 108'	64		
2" (48mm) x 66'	80		
2" (48mm) x 108'	48		
3" (72mm) x 108'	32		
4" (96mm) x 108'	24		
49" (1250mm) x 66'	2		
49" (1250mm) x 108'	2		

\*1" UL listed core.

Alternative to Permacel #220; IPG #6180; Tesa #4208; Berry Global #777.

3/4" (19mm) x 60'	100		
Also sold in subpacks of 10 rolls: @ /roll			

3/4" (19mm) x 66'	100		
Also sold in subpacks of 10 rolls: @ /roll			

(11) COLORS AVAILABLE: Black, white, green, orange, red, blue, yellow, purple, gray, brown & pink.

3/4" (19mm) x 66'	100		
Also sold in subpacks of 10 rolls: @ /roll			

All colors except black.

3/8" (9mm) x 66'	264		
1/2" (12mm) x 66'	192		
1" (24mm) x 66'	96		
1.5" (36mm) x 66'	64		
2" (48mm) x 66'	48		
3" (72mm) x 66'	32		
49" (1250mm) x 66'	2	same color	

(8) COLORS AVAILABLE: Black, white, green, orange, red, blue, yellow & gray.

3/4" (19mm) x 66'	200		
Also sold in subpacks of 10 rolls: @ /roll			

Alternative to Permacel #P-29+, 3M #33.

3/8" (9mm) x 66'	264		
1/2" (12mm) x 66'	192		
1" (24mm) x 66'	96		
1.5" (36mm) x 66'	64		
2" (48mm) x 66'	48		
3" (72mm) x 66'	32		
4" (96mm) x 66'	24		
49" (1250mm) x 66'	2		

# Heavy-Duty SPVC Vinyl Tapes...

Heavy-duty SPVC Pipe Wrap/Surface Protection Tapes are highly resistant to sun, water, oil, acids, alkalies and corrosive chemicals. Bacteria and fungus resistant. Abrasion resistant. Provides electrical protection. Protects pipe joints, conduit couplings for overhead or direct buried applications. Application Temperature: 32°F. Water absorption rate (maximum): 0.290 (25°C, 24 hours).

## PWT-10C... BLACK SPVC Pipe Wrap

**10 mil** (0.25mm). SPVC pipe wrap/surface protection film. Matte surface, rubber adhesive. **Flame Retardant**. Adhesion: 14 oz/in. Tensile: 20 lb/in. Elongation: 250%. Dielectric Strength: 1 KV/mil. Temperature Resistance: 176°F (80°C). 3" neutral paper core.

WIDTH	RLS/CS	CASES		
		1-11	12-29	30+
<b>33.3 YD (100 FT) BLACK</b>				
3/4"	(19mm)	64		
<b>1"</b>	<b>(25mm)</b>	<b>48</b>		
<b>1.5"</b>	<b>(38mm)</b>	<b>32</b>		
<b>2"</b>	<b>(50mm)</b>	<b>24</b>		
<b>3"</b>	<b>(75mm)</b>	<b>16</b>		
<b>4"</b>	<b>(100mm)</b>	<b>12</b>		
<b>5"</b>	<b>(125mm)</b>	<b>8</b>		
<b>6"</b>	<b>(150mm)</b>	<b>8</b>		
49"	(1250mm)	LOG		
49"	(1250mm)	2		

Alternative to 3M #50; Achem #PW10; Shurtape #PW100 Permacel #306.

## PWT-10H... WHITE SPVC Pipe Wrap

Same specs as PWT-10C. 1.5" (38.1mm) core for HVAC industry.

<b>33.3 YD (100 FT) WHITE</b>				
1"	(25mm)	48		
1.5"	(38mm)	24 or 32		
2"	(50mm)	24		
49"	(1250mm)	LOG		
49"	(1250mm)	2		

## PWT-10G... GREEN SPVC Pipe Wrap

Same specs as PWT-10C. 1.5" (38.1mm) core for HVAC industry.

<b>33.3 YD (100 FT) GREEN</b>				
2"	(50mm)	24		

## PWT-20C... BLACK SPVC Pipe Wrap

**20 mil** (0.50mm). SPVC pipe wrap/surface protection film. Matte surface, rubber adhesive. **Flame Retardant**. Adhesion: 11 oz/in. Tensile: 32 lb/in. Elongation: 360%. Temperature Resistance: 176°F (80°C). 3" neutral paper core.

<b>33.3 YD (100 FT) BLACK</b>				
3/4"	(19mm)	64		
1"	(25mm)	48		
<b>1.5"</b>	<b>(38mm)</b>	<b>32</b>		
<b>2"</b>	<b>(50mm)</b>	<b>24</b>		
<b>3"</b>	<b>(75mm)</b>	<b>16</b>		
<b>4"</b>	<b>(100mm)</b>	<b>12</b>		
49"	(1250mm)	LOG		

Alternative to Permacel #P-320; Achem #PW20.

# Hazard Identification Barricade Tapes...

## BRC... Barricade Tapes

Non-adhesive, 3 mil polyethylene film. Stocked\* barricade tape legends/colors are listed below.

WIDTH x LENGTH	RLS/CS	ROLL	CASES	
			1-5	6+
3" x 300'	24			
3" x 1000'	8			
6" x 1000'	4			

	WIDTH	LENGTH	STOCKED LEGENDS	COLORS
BRC-CC	3"	x 300'	CAUTION • CAUTION • CAUTION	Black Legend on Yellow Film
BRC-CUIS	3"	x 300'	CUIDADO • CUIDADO • CUIDADO	Black Legend on Yellow Film
BRC-CC	3"	x 1000'	CAUTION • CAUTION • CAUTION	Black Legend on Yellow Film
BRC-CUIS	3"	x 1000'	CUIDADO • CUIDADO • CUIDADO	Black Legend on Yellow Film
BRC-SCUI	3"	x 1000'	CUIDADO • CAUTION	Black Legend on Yellow Film
BRC-CCA	3"	x 1000'	CAUTION CONSTRUCTION AREA	Black Legend on Yellow Film
BRC-CDNE	3"	x 1000'	CAUTION DO NOT ENTER	Black Legend on Yellow Film
BRC-COT	3"	x 1000'	CAUTION OPEN TRENCH	Black Legend on Yellow Film
BRC-FLDNC	3"	x 1000'	FIRE LINE DO NOT CROSS	Black Legend on Yellow Film
BRC-PLDNC	3"	x 1000'	POLICE LINE DO NOT CROSS	Black Legend on Yellow Film
BRC-SLDNC	3"	x 1000'	SHERIFF'S LINE DO NOT CROSS	Black Legend on Yellow Film
BRC-DD	3"	x 1000'	DANGER • DANGER • DANGER	Black Legend on Red Film
BRC-DDNE	3"	x 1000'	DANGER DO NOT ENTER	Black Legend on Red Film
BRC-RNP	3"	x 1000'	RED - NO IMPRINT	Red
BRC-YNP	3"	x 1000'	YELLOW - NO IMPRINT	Yellow
BRC-R/W	3"	x 1000'	RED/WHITE STRIPES	Red/White
BRC-B/Y	3"	x 1000'	BLACK/YELLOW STRIPES	Black/Yellow
<b>UNDERGROUND TAPES</b>				
BRC-BSLB	6"	x 1000'	CAUTION BURIED SEWER LINE BELOW	Black Legend on Green Film
BRC-BWLB	6"	x 1000'	CAUTION BURIED WATER LINE BELOW	Black Legend on Blue Film

\*NOTE: Custom imprints and other solid colors available. Email/call for pricing and availability.

# Solid SPVC Vinyl Colored Tapes...

**CVT-536... 36 yd.**

**CVT-560... 60 yd.**

Colored Vinyl Tapes (matte surface-soft PVC). 3" neutral core/carton.

**13 OSHA COLORS: Yellow, white, black, clear, red, orange, light blue, dark blue, gray, purple, emerald green, kelly green & dark brown.**

### Applications...

Used for color coding; lane marking and safety coding to meet OSHA requirements; decorating, striping on vehicles, boats, sporting equipment, etc. Masking for hard chrome plating & anodizing; harness and pipe wrapping. Duct and joint sealing.

### Features/Benefits...

Product is of superior quality, with a long shelf-life, and "write-on" capability. It provides a very effective vapor and moisture barrier. It is highly conformable and resistant to aging, sun, water, fungus, bacteria, oil, acids, alkalis and corrosive chemicals. It provides good abrasion, impact and rupture resistance. 3" neutral core.

### Physical Properties...

Backing	Matte surface, soft PVC
Adhesive	Synthetic & Natural Rubber Resin Blend
Total Thickness	5.2 mil (0.13mm)
Adhesion to Steel	18 oz/in.
Tensile Strength	14 lbs/in.
Elongation	150% at break

WIDTH	RLS/CS	CASES		
		1-11	12-29	30+
<b>CVT-536</b>	<b>36 YD (33M) 108 FT</b>	<b>3" CORE</b>		
1/4"	(6mm) 192			
3/8"	(9mm) 128			
1/2"	(12mm) 96			
<b>3/4"</b>	<b>(18mm) 64</b>			
<b>1"</b>	<b>(24mm) 48</b>			
1.5"	(36mm) 32			
<b>2"</b>	<b>(48mm) 24</b>			
<b>3"</b>	<b>(72mm) 16</b>			
<b>4"</b>	<b>(96mm) 12</b>			
5"	(120mm) 8			
6"	(144mm) 8			
49"	(1250mm) LOG		neutral core	
49"	(1250mm) 2		same color	
49"	(1250mm) 54		crate - 1 color	

WIDTH	RLS/CS	CASES		
		1-11	12-29	30+
<b>CVT-560</b>	<b>60 YD (55M) 180 FT</b>	<b>3" CORE</b>		
1/2"	(12mm) 96			
3/4"	(18mm) 64			
1"	(24mm) 48			
1.5"	(36mm) 32			
<b>2"</b>	<b>(48mm) 24</b>			
3"	(72mm) 16			
4"	(96mm) 12			
6"	(144mm) 8			
49"	(1250mm) LOG		neutral core	
49"	(1250mm) 2		same color	
49"	(1250mm) 40		crate - 1 color	

# SPVC Vinyl Die Cuts On A Roll...

## DOTS & ARROWS

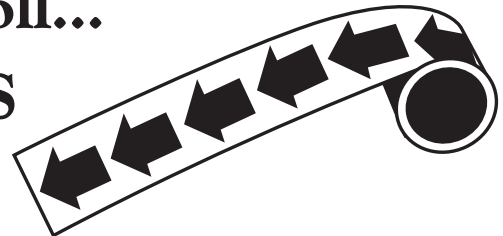
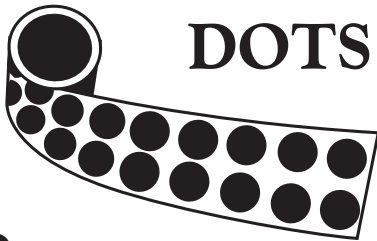

**CVT-D... Dots**

**CVT-A... Arrows**

Pressure sensitive dots & arrows. Used for aisle marking, color coding, inventory identification, defect markings, and numerous other applications. Made of durable vinyl construction, product is waterproof and will withstand heavy traffic.

**12 COLORS AVAILABLE: Yellow, white, black, clear, red, orange, light blue, dark blue, gray, purple, dark green & dark brown.**

**For clear vinyl, add 30% to roll cost.**

**For exterior use, specify -L for laminated film to reduce fading. Add 25% (x 1.25) to roll cost.**

**Specify DOTS or ARROWS when ordering.**

SIZE	UNITS/ROLL	COST/ROLL
1/2" *	1,000	
3/4" *	1,000	
1"	1,000	
2"	500	
3"	500	
4"	500	
5"	500	

\*Dots ONLY. Arrows not available in these widths.

Minimum order for Dots & Arrows is

Custom colors & die-cuts also available. Call for pricing.



# Solid SPVC Vinyl Colored Tapes...

**CVT-636... 36 yd.**

**CVT-660... 60 yd.**

Colored Vinyl Tapes (matte surface-soft PVC). 3" neutral core/carton.

**16 OSHA COLORS: Black, white, clear, yellow, red, orange, light green\*, kelly green, emerald green, sky blue, medium blue\*, dark blue, medium brown\*, dark brown, gray & purple.**  
**\*Light green, medium blue & medium brown STOCKED in 36 yd. lengths only.**

### Applications...

Used for color coding; lane marking and safety coding to meet OSHA requirements; decorating, striping on vehicles, boats, sporting equipment, etc. Masking for hard chrome plating & anodizing; harness and pipe wrapping. Duct and joint sealing.

### Features/Benefits...

Product is of superior quality, with a long shelf-life, and "write-on" capability. It provides a very effective vapor and moisture barrier. It is highly conformable and resistant to aging, sun, water, fungus, bacteria, oil, acids, alkalies and corrosive chemicals. It provides good abrasion, impact and rupture resistance.

### Physical Properties...

Backing	Matte surface, soft PVC
Adhesive	Synthetic & Natural Rubber Resin Blend
Total Thickness	6 mil (0.15mm)
Adhesion	22 oz/in.
Tensile Strength	16 lbs/in.
Elongation	150% at break
Temperature Resistance	-20°F to +176°F
Moisture Absorption	Less than 1.5%
Moisture Vapor Transmission	Less than 2.5% (gm/100 sq in/24 hrs)
Metal Corrosion	None to copper, brass, steel, aluminum
Accelerated Aging Factor	Greater than 100% (% of original adhesion to backing after aging)
Government Specifications	Conforms to A-A-1689B, Type II (meets cancelled spec PPP-T-66E, Type 1, Class 2)

**CVT-636P... 36 yd. 3" plastic cores.**

**CVT-660P... 60 yd. 3" plastic cores. WHITE ONLY**

Colored Vinyl Tapes (matte surface-soft PVC). 3" plastic core/neutral carton.

**9 OSHA COLORS: Black, white, clear, yellow, red, orange, kelly green, sky blue & dark blue.**

Other colors available as special order. Call for details.

WIDTH	RLS/CS	CASES		
		1-11	12-29	30+
<b>CVT-636 36 YD (33M) 108 FT 3" CORE</b>				
1/4"	(6.3mm)	192		
3/8"	(9mm)	128		
1/2"	(12mm)	96		
3/4"	(19mm)	64		
1"	(25mm)	48		
1.25"	(31.7mm)	38		
1.5"	(38mm)	32		
2"	(50mm)	24		
2.5"	(63.5mm)	20		
3"	(75mm)	16		
4"	(100mm)	12		
5"	(125mm)	8		
6"	(150mm)	8		
49"	(1250mm)	LOG	neutral core	
49"	(1250mm)	2	same color	
49"	(1250mm)	48	crate - 1 color	

Alternative to 3M #471 & #764; Permaceal #P-33 & P-34; Cantech #571; Shurtape VP410; Achem #ST40; Decker #44; Patco #10; Achem #410 & #419.

<b>CVT-660 60 YD (55M) 180 FT 3" CORE</b>				
3/8"	(9mm)	128		
1/2"	(12mm)	96		
3/4"	(19mm)	64		
1"	(25mm)	48		
1.5"	(38mm)	32		
2"	(50mm)	24		
3"	(75mm)	16		
4"	(100mm)	12		
5"	(125mm)	8		
6"	(150mm)	8		
49"	(1250mm)	LOG	neutral core	
49"	(1250mm)	2	same color	
49"	(1250mm)	35	crate - 1 color	

\*60 yd stocked in all colors EXCEPT medium brown, medium blue & light green.

<b>CVT-636P 36 YD (33M) 108 FT 3" CORE</b>				
1/4"	(6.3mm)	192		
1/2"	(12mm)	96		
3/4"	(19mm)	64		
1"	(25mm)	48		
1.5"	(38mm)	32		
2"	(50mm)	24		
3"	(75mm)	16		
4"	(100mm)	12		
49"	(1250mm)	LOG	plastic core	
49"	(1250mm)	40	crate-1 color	

Alternative to PATCO #150-PL; Achem #419P.

<b>CVT-660P 60 YD (55M) 180 FT 3" CORE</b>				
WHITE ONLY				
49"	(1250mm)	LOG	plastic core	

Slit rolls proportional cost to 36 yd.

See page 11 for AISLE MARKING TAPE DISPENSER.

# Striped Safety Warning Tapes...

**SST-618... 18 yd.**

**SST-636... 36 yd.**

6 mil (0.15mm). Conformable Soft PVC Vinyl. Synthetic Rubber Adhesive, self-extinguishing. Adhesion: 13.7 oz/in. Tensile Strength: 15 lbs/in. Elongation: 210% at break. Temperature Resistance: 14°F to + 176°F. Will not corrode copper, brass, steel, or aluminum. For striping & warning, marking of hazardous areas and exits to comply with OSHA requirements per paragraph 1910.144 of the Federal Register. 3" neutral paper core.

Colors Available	Typical Uses...
Black/yellow	Physical Hazard/Caution
Red/white	Fire Equipment/First Aid
Black/white	Traffic/Housekeeping
Green/white	Decorative Identification
Magenta/yellow <sup>Ⓜ</sup>	Radiation Hazard

<sup>Ⓜ</sup>Only available in 36 yd.



WIDTH	RLS/CS	CASES		
		1-11	12-29	30+
<b>SST-618</b>		18 YD (16.5M) 54 FT		
1/2"	(12mm)	96		
3/4"	(18mm)	64		
1"	(24mm)	48		
2"	* (48mm)	24		
3"	* (72mm)	16		
4"	(96mm)	12		
49"	(1250mm)	LOG	neutral core	
49"	(1250mm)	2	same color	

**SST-636** 36 YD (33M) 108 FT

1/2"	(12mm)	96		
3/4"	(18mm)	64		
1"	(24mm)	48		
2"	* (48mm)	24		
3"	* (72mm)	16		
4"	(96mm)	12		
49"	(1250mm)	LOG	neutral core	
49"	(1250mm)	2	same color	

\* Lower proportional price, as stocked pre-slit.

**SST-718... 18 yd.**

**SST-736... 36 yd.**

7 mil (0.175mm). **Conformable Soft PVC Vinyl.** Synthetic Rubber Adhesive, self-extinguishing. Adhesion: 22 oz/in. Tensile Strength: 18 lbs/in. Elongation: 200%. Temperature Resistance: up to 140°F. Will not corrode copper, brass, steel, or aluminum. For striping & warning, marking of hazardous areas and exits to comply with OSHA requirements per paragraph 1910.144 of the Federal Register. 3" neutral core.

Colors Available	Typical Uses...
Black/yellow	Physical Hazard/Caution
Red/white	Fire Equipment/First Aid
Black/white	Traffic/Housekeeping
Green/white	Decorative Identification



**SST-718** 18 YD (16.5M) 54 FT

1/2"	(12mm)	96		
3/4"	(19mm)	64		
1"	(25mm)	48		
2"	* (50mm)	24		
3"	* (75mm)	16		
4"	(100mm)	12		
6"	(150mm)	8		
49"	(1250mm)	LOG	neutral core	
49"	(1250mm)	2	same color	

Alternative to 3M #5700 and #5702; Achem #41N; Shurtape #VP415.

**SST-736** 36 YD (33M) 108 FT

1/2"	(12mm)	96		
3/4"	(19mm)	64		
1"	(25mm)	48		
2"	* (50mm)	24		
3"	* (75mm)	16		
4"	(100mm)	12		
6"	(150mm)	8		
49"	(1250mm)	LOG	neutral core	
49"	(1250mm)	2	same color	

\* Lower proportional price, as stocked pre-slit.

# Vinyl Electroplating Tape...

**EPT-38...SPVC Masking tape for Electroplating**

6.8 mil (.017mm) Yellow Soft PVC Film. Rubber resin adhesive. Extremely conformable, durable and highly resistant to oil, acid, alkalines, corrosive chemicals. Excellent adhesion to metals, plastics. Designed for use with PCB terminal zone contacts to prevent penetration of chemicals during plating process; as a protection tape for shot peening applications. Adhesion: 17 oz/in. Tensile Strength: 16 lbs/in. Elongation: 100% at break. Operating Temperature: 140°F (60°C) to 194°F (90°C). 3" paper core/carton.

WIDTH	RLS/CS	CASES		
		1-4	5-9	10+
		36 YD (33M) 108 FT		
1/2"	(12.5mm)	96		
3/4"	(19mm)	64		
1"	(25mm)	48		
1.5"	(38mm)	32		
2"	(50mm)	24		
3"	(75mm)	16		
4"	(100mm)	12		
6"	(150mm)	8		
51"	(1300mm)	LOG	neutral core	

Alternative to Permacel #P-35; 3M #470; Plymouth Rubber #7.

# Striped Safety Warning Tapes...

**SST-718L... 18 yd.**

**SST-736L... 36 yd.**

6.3 mil (0.16mm). **Laminated SPVC** with rubber based adhesive. Shiny surface. Adhesion/Steel: 17.6 oz/in. Tensile Strength: 18 lbs/in. Elongation: 180%. Resists oil, grease, solvents, moisture. Scuff resistant. For marking fire equipment/exits, hazardous areas, and first aid points. 3" neutral paper core.

Colors Available	Typical uses...
Black/yellow	Physical Hazard/Caution
Red/white	Fire Equipment/First Aid
Black/white	Traffic/Housekeeping
Green/white <sup>¶</sup>	Decorative Identification
Magenta/yellow	Radiation Hazard



<sup>¶</sup>Only available in 36 yd.

WIDTH	RLS/CS	CASES		
		1-11	12-29	30+
<b>SST-718L</b>		<b>18 YD (16.5M) 54 FT</b>		
1"	(24mm)	48		
2"	(48mm)	24		
3"	(72mm)	16		
4"	(96mm)	12		
49"	(1250mm)	LOG		neutral core
49"	(1250mm)	2		same color

WIDTH	RLS/CS	CASES		
		1-11	12-29	30+
<b>SST-736L</b>		<b>36 YD (33M) 108 FT</b>		
1"	(24mm)	48		
2"	(48mm)	24		
3"	(72mm)	16		
4"	(96mm)	12		
49"	(1250mm)	LOG		neutral core
49"	(1250mm)	2		same color

Alternative to Achem #V16.

**SST-918L... 18 yd.\***

**SST-936L... 36 yd.**

9.1 mil (0.23mm). **Laminated SPVC** with rubber based adhesive. Shiny surface. Adhesion/Steel: 22 oz/in. Tensile Strength: 33 lbs/in. Elongation: 200%. Resists oil, grease, solvents, moisture. Scuff resistant. For marking fire equipment/exits, hazardous areas, and first aid points. Meets government specification A-A-1689B Type II. 3" neutral paper core.

**COLORS AVAILABLE:**  
Black/Yellow, Red/White & Black/White.

\*SST-918L also available with plastic cores. Add 10% and specify "PC" for plastic cores (stocked in 18 yd ONLY).



WIDTH	RLS/CS	CASES		
		1-11	12-29	30+
<b>SST-918L</b>		<b>18 YD (16.5M) 54 FT</b>		
1"	(25mm)	48		
2"	(50mm)	24		
3"	(75mm)	16		
4"	(100mm)	12		
6"	(150mm)	8		
49"	(1250mm)	LOG		neutral core
49"	(1250mm)	2		same color

WIDTH	RLS/CS	CASES		
		1-11	12-29	30+
<b>SST-936L</b>		<b>36 YD (33M) 108 FT</b>		
1"	(25mm)	48		
2"	(50mm)	24		
3"	(75mm)	16		
4"	(100mm)	12		
6"	(150mm)	8		
49"	(1250mm)	LOG		neutral core
49"	(1250mm)	2		same color

Alternative to Achem #V12; ST-V10.

**2LM...** For lane marking tape up to 4" wide **Aisle/lane marking tape dispenser.** 3" core. Individually cartoned. "NOT RETURNABLE"

Refer to pages 8-11 for vinyl aisle marking tapes.

Also can use with cloth duct tape... see page 3.



COST EACH	UNITS/CASE	CASE QTY EACH
	10	
	Crate of 50	/crate

Replacement Parts:  
DP-002LMSAS Spool Axle Set  
B-2LM000000 Cartons K.D. for above  
/each ( for pack of 50)

# Dry Vinyl Tape...

**DVT-76Y... Yellow**

3.94 mil (0.10mm) total thickness. Non-adhesive plasticized poly-vinyl chloride film tape. Easy unwinding characteristics - tape clings firmly to it's own backing for tight wrap. High elongation and good strength to permit trouble-free binding of wiring harnesses for the automotive industry. Dry vinyl tape also used for plating applications - high stretch, good "cling" characteristics and great conformability provide for superior masking in hard chrome and other plating applications. UL510 Flame Resistant. Cold flexibility - no cracking. Tensile Strength: 8.6 lbs/in. Elongation: 200%. Meets certificate standard: CE. 1 1/2" (38.1mm) paper core.

WIDTH	RLS/CS	CASES		
		1-11	12-29	30+
<b>DVT-76Y</b>		<b>76M (250 FT)</b>		
1/2"	(12mm)	256		
3/4"	(18mm)	160		
1"	(24mm)	128		
1.5"	(36mm)	80		
2"	(48mm)	64		
3"	(72mm)	40		
4"	(96mm)	32		
48"	(1220mm)	LOG		neutral core

\* Lower proportional price, as stocked pre-slit.  
Minimum 6 inches @ 1-11 case price +10%.

# Pipe Thread Seal Tapes...

**PTFE-35S... Standard Density**

**PTFE-35H... High Density**



100% Virgin PTFE. 3.5 mil white film in labeled plastic spool/box. Available in Standard Density (PTFE-35S) and High Density (PTFE-35H). Lubricates joints, making them easy to assemble for leak proof seals. For all industrial applications, including water, oil, gas, most chemicals, hydraulic and high pressure lines. MIL Spec T-27730A & UL31 RO. Elongation >50%. Temperature Range: -450°F to 500°F. 5 sub-packs per carton.

Physical Properties...	PTFE-35S Standard Density	PTFE-35H High Density
Density	0.26 gm/cm <sup>3</sup>	0.31 gm/cm <sup>3</sup>
Tensile Strength	6.8 N/m <sup>2</sup>	9.9 N/m <sup>2</sup>

**Unsintered Virgin Polytetrafluoroethylene (PTFE)**

WIDTH x LENGTH	RLS/CS	CASES		
		1-3	4-7	8+
<b>PTFE-35S</b>				
1/2" x 260"	500			
1/2" x 520"	500			
3/4" x 520"	350			
1" x 520"	250			

**PTFE-35H**

1/2" x 260"	500			
1/2" x 520"	500			
3/4" x 520"	350			
1" x 520"	250			

Alternative to 3M #48 & #547.

# Polyethylene Film Tapes...

**LDPE-5AE... Economical Acrylic Adhesive**

5.2 mil Low Density Polyethylene Film Tape. Acrylic Adhesive. Cost effective alternative to LDPE-5A. Its adhesive system provides good adhesion for surface protection applications. The tough polyethylene backing offers good abrasion and tear resistance. UV and solvent resistant. Long term aging stability without yellowing. Tape will not crack or craze after extended exposure. 3" plastic core.

### Applications...

Splicing, general purpose sealing/seaming and spiral wrapping, protective overlaminates & patching where a highly conformable and clear material is required.

### Physical Properties...

Tensile Strength	4.6 lbs/in
Elongation	200%
Peel Adhesion	27 oz/in.
Application Temperature	50°F to 122°F
Operating Temperature	-40°F to 185°F

**LDPE-5A... with Acrylic Adhesive**

**LDPE-5R... with Rubber Adhesive**

5.5 mil (0.14mm) Low Density Polyethylene Film Tapes. Good abrasions, chemical, tear and UV resistance. Excellent moisture barrier. Used for color coding, decorative markings, stripping, sealing, splicing & seaming. 3" plastic core.

### Typical Applications...

**LDPE-5A** – Provides high adhesion and cohesion which yields a permanent bond with virtually no edge bleed out. Excellent long term aging stability without yellowing. Will not crack or crease at low temperatures.

**LDPE-5R** – Ideal for polyethylene splicing; general purpose sealing, spiral wrapping. Suitable for use in nuclear and other sensitive environments. Highly conformable and adheres to most surfaces. Works well in most applications where low to moderate adhesion is required.

Physical Properties...	LDPE-5A	LDPE-5R
Adhesive	Acrylic	S.B. Synthetic Rubber
Tensile Strength	11 lbs/in	10 lbs/in
Elongation	400%	350%
Adhesion to Steel	56 oz/in	28 oz/in
Application Temperature	50°F to 120°F	50°F to 120°F
Operating Temperature	-40°F to 190°F	-40°F to 190°F

Alternative to 3M #480 (acrylic), #483 (rubber); Patco #502A, #503A (acrylic), #502R & #503R (rubber).

WIDTH	RLS/CS	CASES		
		1-5	6-11	12+
60 YD (55M) 180 FT				
1/2"	(12mm)	96		
3/4"	(18mm)	64		
1"	(24mm)	48		
1.5"	(36mm)	32		
2"	(48mm)	24		
3"	(72mm)	16		
4"	(96mm)	12		
6"	(144mm)	8		
39.4"	(1000mm)	LOG		

**1 COLOR AVAILABLE: Clear.**

**LDPE-5A 36 YD (33M) 108 FT**

1/4"	(6mm)	192
3/8"	(9mm)	128
1/2"	(12mm)	96
3/4"	(18mm)	64
1"	(24mm)	48
1.5"	(36mm)	32
2"	(48mm)	24
3"	(72mm)	16
4"	(96mm)	12
6"	(144mm)	8
54"	(1371mm)	LOG

**LDPE-5A COLORS (8): Clear, black, white, red, green, blue, yellow & orange.**

**LDPE-5R 36 YD (33M) 108 FT**

1/4"	(6mm)	192
3/8"	(9mm)	128
1/2"	(12mm)	96
3/4"	(18mm)	64
1"	(24mm)	48
1.5"	(36mm)	32
2"	(48mm)	24
3"	(72mm)	16
4"	(96mm)	12
6"	(144mm)	8
54"	(1371mm)	LOG

**LDPE-5R COLORS (4): Clear, black, white, red.**

**NOTE: Other colors available as special order.**

# Polyethylene Film Tapes...

## LDPE-7R...

7.0 mil (0.178mm) total thickness. 4.5 mil low density polyethylene film coated on one side with a synthetic rubber adhesive. Tough polyethylene backing offers good abrasion and tear resistance. Low tack adhesive suitable for surface protection applications. Excellent for low temperature bonding. 3" paper core.

### Applications...

Ideal for wire identification, surface protection, seaming and splicing of films.

### Physical Properties...

Adhesive	Synthetic Rubber
Tensile Strength	18 lbs/in.
Elongation	80%
Peel Adhesion	60 oz/in.
Adhesion to Backing	35 oz/in.

## LDPE-7R/UV...

7.0 mil (0.178mm) total thickness. 4.5 mil low density polyethylene film coated on one side with a synthetic rubber adhesive. Backing has been stabilized with additives to resist the effects of UV exposure. Leaves \*no residue\* upon removal on most surfaces (testing required). Maintains a water tight seal in all weather conditions. Its adhesive system remains permanently tacky and bonds well to most surfaces over a wide range of temperatures. 3" paper core.

### Applications...

Designed for masking of windows and doors in stucco applications. Ideal for polyethylene splicing or seaming in construction applications.

### Physical Properties...

Adhesive	Synthetic Rubber
Tensile Strength	18 lbs/in.
Elongation	80%
Peel Adhesion	60 oz/in.
Adhesion to Backing	35 oz/in.

## LDPE-9R...

9.0 mil (0.229mm) total thickness. 5.5 mil low density polyethylene film coated on one side with a synthetic rubber adhesive. Remains permanently tacky and bonds well to most surfaces over a wide range of temperatures; excellent low temperature bond. Tough polyethylene backing offers good abrasion and tear resistance. Highly conformable, waterproof and resistant to chemical deterioration. 3" paper core.

### Applications...

Ideal for polyethylene splicing; patching/repairing poly sheeting used in boating and RV industry; surface protection & electroplate masking; wire identification; packaging; etc. Works well in most applications where a low thread-count polyethylene coated cloth tape is being used.

### Physical Properties...

Adhesive	Synthetic Rubber
Tensile Strength	22 lbs/in.
Elongation	100%
Peel Adhesion	70 oz/in.
Adhesion to Backing	35 oz/in.

WIDTH	RLS/CS	CASES		
		1-5	6-11	12+
<b>60 YD (55M) 180 FT</b>				
1/4"	(6mm)	144 or 192		
3/8"	(9mm)	128		
1/2"	(12mm)	96		
3/4"	(18mm)	64		
1"	(24mm)	48		
1.5"	(36mm)	32		
2"	(48mm)	24		
3"	(72mm)	16		
4"	(96mm)	12		
6"	(144mm)	8		
50"	(1270mm)	LOG		

Alternative to Scapa #135; Berry Global #833 & #757.

### 3 COLORS AVAILABLE: Clear, white & red.

(\*Other colors available as special order; MOQ = 6 logs.)

60 YD (55M) 180 FT		
1"	(24mm)	48
1.5"	(36mm)	32
2"	(48mm)	24
3"	(72mm)	16
4"	(96mm)	12
6"	(144mm)	8
50"	(1270mm)	LOG

Alternative to Scapa #234, Berry Global Red Baron #824 & #836; Permacel #224LB; Cantech #250.

### 2 COLORS AVAILABLE: White & red.

\*Note: Clean removability is dependent upon dwell time, the conditions/temperature of exposure, surfaces, etc. Should be thoroughly tested in the specific application.

36 YD (33M) 108 FT		
1/2"	(12mm)	96
3/4"	(18mm)	64
1"	(24mm)	48
1.5"	(36mm)	32
2"	(48mm)	24
3"	(72mm)	16
4"	(96mm)	12
6"	(144mm)	8
50"	(1270mm)	LOG

60 YD (55M) 180 FT		
1/2"	(12mm)	96
3/4"	(18mm)	64
1"	(24mm)	48
1.5"	(36mm)	32
2"	(48mm)	24
3"	(72mm)	16
4"	(96mm)	12
6"	(144mm)	8
50"	(1270mm)	LOG

Alternative to 3M #481, Berry Global #827; Scapa #136; PATCO #5400; Shurtape #VP555; Cantech #278.

### 7 COLORS AVAILABLE: Clear, black, white, red, green, blue\* & yellow\*.

\*Blue & yellow are stocked in 36Yd only.

(\*Other colors available as special order; MOQ = 6 logs.)

# Non-Skid Safety Tapes...

"Sure-Step" non-skid safety tapes provide a high traction, anti-slip, waterproof surface to help prevent slips and falls. Aggressive acrylic adhesive bonds to a variety of materials and conforms to irregular surfaces. For use indoors & outdoors; on walkways, ramps, stairways; in machine shops & work areas, etc; to comply with OSHA 1910.263 (3).

White liner. 3" neutral core. **All prices are per roll by case volume.**

## NST-20... BLACK

32 mil. 60 grit silicon carbide.

**Black (ONLY) is available for purchase by the roll. For less than case quantities, add 10% to 1-5 case column.**



WIDTH	RLS/CS	CASES		
		1-5	6-11	12+
<b>20 YD (60 FT) BLACK</b>				
1"	(25mm)	12		
1.5"	(38mm)	8		
2"	(50mm)	6		
3"	(75mm)	4		
4"	(100mm)	3		
6"	(150mm)	2		
8"	(200mm)	1		
12"	(300mm)	1		
18"	(450mm)	1		
24"	(600mm)	1		
36"	(925mm)	1		

Alternative to 3M Safety Walk™, Jessup Safety Track™ 3100; TLC #CT806.

## NST-20B/Y... BLACK/YELLOW

32 mil. 60 grit silicon carbide on black stripe, 60 grit aluminum oxide on yellow stripe.

**Full case quantities ONLY.**



WIDTH	RLS/CS	CASES		
		1-3	4-7	8+
<b>20 YD (60 FT) BLACK/YELLOW OR LUMINOUS</b>				
1"	(25mm)	12		
2"	(50mm)	6		
3"	(75mm)	4		
4"	(100mm)	3		
6"	(150mm)	2		
12"	(300mm)	1		

## **NEW** NST-20GL... LUMINOUS

41 mil. **Luminescent, GLOW-in-the-DARK** backing impregnated with 60 grit aluminum oxide. **Full case quantities ONLY.**

## **NEW** NST-20GS... BLACK WITH GLOW INSERT

39 mil. **BLACK** 60 grit aluminum oxide with **GLOW-in-the-DARK** insert/stripe (10mm) in the center. **Full case quantities ONLY.**



<b>20 YD (60 FT) BLACK WITH GLOW INSERT</b>		
2"	(50mm)	6

## NST-20C... COLORS

32 mil. 60 grit aluminum oxide.

**Full case quantities ONLY.**

**8 COLORS AVAILABLE:** White, translucent (clear), gray, red, orange, yellow, dark green & dark blue.

<b>20 YD (60 FT) COLORS</b>		
1"	(25mm)	12
1.5"	(38mm)	8
2"	(50mm)	6
3"	(75mm)	4
4"	(100mm)	3
6"	(150mm)	2
12"	(300mm)	1

## NST-20F... FLUORESCENT COLORS

32 mil. 60 grit aluminum oxide.

**Full case quantities ONLY.**

**3 COLORS AVAILABLE:** Red, orange & yellow.

<b>20 YD (60 FT) FLUORESCENT COLORS</b>		
1"	(25mm)	12
1.5"	(38mm)	8
2"	(50mm)	6
3"	(75mm)	4
4"	(100mm)	3
6"	(150mm)	2
12"	(300mm)	1

# Non-Skid Safety Strips/Cleats...

Non-skid safety tape in pre-slit strips & cleats. Gritty surface increases traction to help prevent slips and falls. Ideal for use on steps, ladders, swimming pools, skateboards, etc. White liner.



## NST-1, 2 or 4 -B... BLACK STRIPS

Various width strips, each 12"(300mm) in length. Packed 10 strips per box.

<b>BLACK STRIPS</b>				
WIDTH	LENGTH	PCS/BOX	BOX/10	
1" (25mm)	x 12" (300mm)	10		
2" (50mm)	x 12" (300mm)	10		
4" (100mm)	x 12" (300mm)	10		

## NST-624B... BLACK CLEATS

Flexible 6"(150mm) x 24" cleats.

Note: Black cleats are also available with a 3/8" **yellow reflective stripe** (1" from the edge of the cleat) for increased hazard awareness. Additional \$1.00 per cleat.

<b>BLACK CLEATS</b>				
WIDTH	x	LENGTH	UNITS	EACH
6" (150mm)	x	24" (609mm)	Each (Minimum 12)	
			Pack (100 Cleats)	
			Carton (200 Cleats)	

# Crepe Paper Masking Tapes...

## GPM-63... General Purpose Masking

5.0 mil (0.125mm). A **utility grade masking tape**, cream color crepe paper with a solvent based natural rubber adhesive system. Tape conforms to a broad range of surfaces. Recommended for general purpose applications such as light bundling, sealing, holding, and air-dry commercial painting (tape removed once paint has dried). Tensile: 19 lbs/in. Elongation: 10% Adhesion: 16 oz/in. Temp. Resistance: 203°F (95°C). 3" TalonTape core.

61" (1550mm) x 1850M (2024 yd) Jumbos Available.



WIDTH	RLS/CS	CASES		
		1-11	12-29	30+
60 YD (55M) 180 FT				
1/4"	(6mm)	144		
3/8"	(9mm)	96		
1/2"	* (12mm)	72		
3/4"	* (18mm)	48		
1"	* (24mm)	36		
1.5"	* (36mm)	24		
2"	* (48mm)	24		
3"	* (72mm)	12		
4"	(96mm)	12		
6"	(144mm)	8		
6"	(152.4mm)	8		
12"	(288mm)	6		
12"	(304.8mm)	6		
61"	(1550mm)	LOG		

Alternative to Tesa #53123 & #50124; Hystik #803; 3M #200 & #2307; Shurtape #CP83 & #CP107; IPG #PG415 & #PG515; Cantech #107-00; Alpha Beta #63.

\* Lower proportional price, as stocked pre-slit.

## HTM-816... High Temp Automotive Masking

6.4 mil (0.162mm) **Premium, high temperature** cream color masking tape with a solvent based cured natural rubber adhesive system designed to work in masking applications where elevated temperatures and solvent resistance are required. Tape can be used at up to 230°F (110°C) for up to one hour while maintaining integrity, holding power and clean removal characteristics. Tape conforms to a broad range of surfaces. Use of a Heavy Crepe Paper provides good tensile strength & tear characteristics as well as excellent elongation for wrapping and masking around curved surfaces. Recommended for high demand painting and masking applications-particularly automotive masking applications. Clean Removal. Adhesion: 35 oz/in. Tensile: 24 lbs/in. Elongation: 10%. 3" TalonTape core.

61" (1550mm) x 1810M (1980 yd) Jumbos Available.

WIDTH	RLS/CS	CASES		
		1-11	12-29	30+
60 YD (55M) 180 FT				
1/4"	(6mm)	144		
3/8"	(9mm)	96		
1/2"	* (12mm)	72		
3/4"	* (18mm)	48		
1"	* (24mm)	36		
1.5"	* (36mm)	24		
2"	* (48mm)	24		
3"	* (72mm)	12		
4"	(96mm)	8 or 12		
6"	(144mm)	8		
61"	(1550mm)	LOG		

Alternative to Hystik #832; 3M #213; Tesa #4318 PV2; Nashua #108N; Alpha Beta #816; Cantech #110-00; Nitto #P-703.

\* Lower proportional price, as stocked pre-slit.

## CPM-60... Colored Masking Tape

5.4 mil. Color saturated crepe paper backing with rubber adhesive. The adhesive is formulated for easy release and good adhesion to a variety of substrates. Designed for color coding for identification or differentiation. Not printable. Conformable to many irregular surfaces. Suitable for bundling, marking of defective parts or materials, produce marking, color coding, and polybag sealing. Adhesion: 32 oz/in. Tensile: 19 lbs/in. Elongation: 7%. Application Temperature: 50°F to 90°F. 3" neutral paper core.

**6 COLORS AVAILABLE: Black, white, red, dark blue, dark green & yellow.**

58.5" (1485mm) X 1524M (1667 yd) approx. Jumbos Available.

WIDTH	RLS/CS	CASES		
		1-11	12-29	30+
60 YD (55M) 180 FT				
1/4"	(6mm)	192		
3/8"	(9mm)	128		
1/2"	(12mm)	96		
5/8"	(15mm)	80		
3/4"	(18mm)	64		
1"	(24mm)	48		
1.5"	(36mm)	32		
2"	(48mm)	24		
3"	(72mm)	16		
4"	(96mm)	12		
6"	(144mm)	8		
12"	(288mm)	6		
58.5"	(1485mm)	LOG		

Alternative to IPG #561 & #PF-3; Shurtape #CP-632; Cantech 120; 3M #262 & #267.

\* Lower proportional price, as stocked pre-slit.

**Most of our items can be custom converted to your needs. Contact us for details!**

# Kraft Flatback Tape...

## KFT-530... Brown Kraft Flatback Tape

7.3 mil. Brown kraft flatback paper coated with a pressure sensitive, natural/synthetic rubber adhesive. This economical, flatback tape offers a positive seal with excellent adhesive properties, designed to minimize carton sealing failures and deter potential theft. Performs well under a wide range of temperature and humidity conditions. Used for carton sealing, packaging, core starting, tabbing, splicing, picture framing, silk screening, and beaming/leasing. Complies with postal regulation for uninsured packages. Meets PPP-T-42C, Type II; CID A-A-883B, Type II. **KFT-530 is not repulpable.** Adhesion to SST: 55 oz/in. Tensile Strength: 42 lbs/in. Elongation: 7%. Temperature Range: 40°F to 175°F. 3" neutral paper core.

## KFT-PM2... Tan Kraft Flatback Tape

6.0 mil. Tan Kraft flatback paper coated with a pressure sensitive, natural rubber resin adhesive. Offers a positive seal and excellent adhesion to discourage pilfering. Good balance of quick stick and holding properties, and can be used on all types of cartons. Performs well under a wide range of temperatures and humidity conditions. Complies with USPS requirements. Meets ASTM D6123, Type II; PPP-T-42C, Type II; CID A-A-883B, Type II; Boeing BAC 5317. **KFT-PM2 is not repulpable.** Adhesion to SST: 57 oz/in. Tensile Strength: 36 lbs/in. Elongation: 3%. Temperature Range: 40°F to 225°F. 3" neutral paper core.

# Flatback Paper Tape...

## CFB-60... Printable Colored Flatback Tape

5.8 mil. Bright, colorful flatback papers coated with a natural rubber adhesive. The flat surface (vs. creped paper) results in high quality printing. Easy unwind characteristic for high speed printing. For flexographic printing, color coding, identification (write-on surface). Tape exhibits high face to face bond strength. Tensile: 32 lbs/in. Adhesion to Steel: 31 oz/in. Elongation: 3%. Meets ASTM D6123, Type II; CID A-A-883B, Type II. 3" neutral paper core.

**1 STANDARD COLOR: White.**

**\*4 ADDITIONAL STOCK COLORS (ADD 10%): Red, yellow, light blue & orange.**

Custom printing available. Call/email for information and pricing.

## CFB-75... Colored Flatback Tape

7.3 mil. Moisture resistant, medium tensile strength, pressure sensitive flatback tape, used for packaging, bookbinding, marking bins and shelves, decorative edging and color coding. Tape is NOT PRINTABLE and not repulpable. Tensile: 48 lbs/in. Adhesion: 60 oz/in. Elongation: 3%. Temperature Resistance: 40°F to 180°F. 3" neutral paper core.

**2 COLORS AVAILABLE: Black & red.**

## CFB-75... as BOOKBINDING TAPE

Can be used in bookbinding applications.

(See page 25 for UPVC bookbinding tapes.)

WIDTH	RLS/CS	CASES		
		1-11	12-29	30+
<b>60 YD (55M) 180 FT</b>				
1/4"	(6mm)	144		
3/8"	(9mm)	96		
1/2"	(12mm)	72 or 96		
3/4"	(18mm)	48 or 64		
1"	(24mm)	36 or 48		
1.5"	(36mm)	24 or 32		
2"	(48mm)	24		
3"	(72mm)	16		
4"	(96mm)	12		
6"	(144mm)	8		
56.25"	(1428mm)	LOG		
56.25"	(1428mm)	360 yd / LOG		

Alternative to IPG #530, #534 & #539; Tesa #4313; HYSTIK #886; Shurtape FP97.

56.25" (1428mm) x 1200 Yd Jumbos Available.

WIDTH	RLS/CS	CASES		
		1-5	6-11	12+
<b>60 YD (55M) 180 FT</b>				
1/4"	(6mm)	144		
3/8"	(9mm)	96		
1/2"	(12mm)	72 or 96		
3/4"	(18mm)	48 or 64		
1"	(24mm)	36 or 48		
1.5"	(36mm)	24 or 32		
2"	(48mm)	24		
3"	(72mm)	16		
4"	(96mm)	12		
6"	(144mm)	8		
58.5"	(1486mm)	LOG		

Alternative to IPG #PM2.

58.5" (1486mm) x 2400 Yd Jumbos Available.

WIDTH	RLS/CS	CASES		
		1-5	6-11	12+
<b>60 YD (55M) 180 FT (WHITE ONLY*)</b>				
1/4"	(6mm)	144		
3/8"	(9mm)	96		
1/2"	(12mm)	72 or 96		
3/4"	(18mm)	48 or 64		
1"	(24mm)	36 or 48		
1.5"	(36mm)	24 or 32		
2"	(48mm)	24		
3"	(72mm)	12 or 16		
4"	(96mm)	12		
6"	(144mm)	8		
12"	(288mm)	4		
57"	(1448mm)	LOG		

Alternative to 3M #250; IPG #PF2; Shurtape #FP-227; Permacel #P-724 & #P726; Achem #IP57.

57" (1448mm) x 2160 Yd Jumbos Available.

WIDTH	RLS/CS	CASES		
		1-5	6-11	12+
<b>60 YD (55M) 180 FT</b>				
1/4"	(6mm)	144		
3/8"	(9mm)	96		
1/2"	(12mm)	72 or 96		
3/4"	(18mm)	48 or 64		
1"	(24mm)	36 or 48		
1.5"	(36mm)	24 or 32		
2"	(48mm)	24		
3"	(72mm)	16		
4"	(96mm)	12		
6"	(144mm)	8		
58"	(1473mm)	LOG		

Alternative to IPG #546; 3M #256.

58" (1473mm) x 1800 Yd Jumbos Available.

<b>600 YD (550M) 1800 FT</b>				
Call for pricing of slit goods (must purchase full web width).				
58"	(1473mm)	LOG		



# Application Tape...

## PRE-MASK...

5.3 mil natural color transfer premask. Translucent saturated paper. Rubber resin based adhesive. Fully compatible for plotter cuts and thermal die cuts of all size die cuts and vinyl lettering. Its medium tack is ideal for most transfer applications. Good resistance to abrasion  
Elongation (at break): 4

□ For trimmed log, specify (-T) and add \$ to log cost.

WIDTH	RLS/CS	100 YD (300 FT)	
		ROLL	CASE
1.5"	(38.1mm)	24	
2.5"	(63.5mm)	18	
3.5"	(88.9mm)	12	
4.5"	(114.3mm)	12	
6"	(152.4mm)	8	
8"	(203.2mm)	6	
<b>DISCONTINUED / SOLD OUT</b>			
14"	(355.6mm)	4	
16"	(406.4mm)	4	
18"	(457.2mm)	4	
20"	(508.0mm)	4	
24"	(609.6mm)	4	
30"	(762.0mm)	4	
48"	(1220.0mm)	LOG	

# Painter's Grade Masking Tape (UV Resistant)...

## PGM-UV14... Blue UV Resistant Masking Tape

5.2 mil Painter's Grade Masking tape with a specially formulated Solvent based rubber adhesive system that provides clean removal characteristics and UV resistance - up to 14 days of outdoor exposure. Special characteristic of the adhesive system is that the peel adhesion does not increase with time, allowing for removal off a wide variety of surfaces without surface damage. \*Rolls are individually edge shrink wrapped - perfect for retail sales. Tensile: 27.8 lbs/in. Peel adhesion: 19.4 oz/in. Maximum temperature resistance: 203°F. Quick stick: 17.6 oz/in. Elongation: 10%. 3" TalonTape core.

61" (1550mm) x 2700M Jumbos Available.

WIDTH	RLS/CS	CASES		
		1-11	12-24	25+
60 YD (55M) 180 FT				
1/2"	(12mm)	72		
3/4"	(18mm)	48		
1"	(24mm)	36		
1.5"	(36mm)	24		
2"	(48mm)	24		
3"	(72mm)	12		
61"	(1550mm)	LOG		

Alternative to Shurtape #CP27; IPG #PT14; Cantech #128-1; 3M #2090, Nashua #140B.

Other roll widths available upon request (custom slit and bulk packed).



# Tamper Evident Tape/Security Tape...

3.9mil Tamper Evident Polyester tape with acrylic adhesive. Carton sealing tapes that leave a security legend deposited on the box or container upon removal, discouraging tampering with and theft of the contents of the sealed cartons. Used in applications where high security is critical: pharmaceuticals, chemical & medical equipment, crime evidence & independent labs, currency handlers, money bags, credit card/security bags, shipping & cargo handlers, transportation in food items; and products of high cost and/or high demand, such as electronics, clothing and sporting goods.

## TEV-ST... Red with Black/White Print

Surface printed with "SECURITY TAPE" in a black and white starburst pattern, with hidden "OPENED VOID" message upon removal. Has an instant initial grab & can be removed immediately to show the invisible legend.



## TEV-OVR... Solid Red

Solid, non-surface printed tape with hidden "OPENED VOID" message upon removal. Has an instant initial grab & can be removed immediately to show the invisible legend.



Specify TEV-ST or TEV-OVR when ordering.

WIDTH	RLS/CS	ROLL		CASE
		ROLL	CASE	
55 YD (50M)				
1/2"	(12mm)	96		
3/4"	(18mm)	64		
1"	(24mm)	48		
1.5"	(36mm)	32		
2"	* (48mm)	24		
		48		
3"	(75mm)	16		
4"	(96mm)	12		
18.9"	(480mm)	LOG		

\* Lower proportional price, as stocked pre-slit.

□ Minimum 6 inches per slit width per item.

**NOW OFFERING: Custom printed tamper evident tape (legend and/or surface printed).** Call/email for information and pricing.

# Polypropylene Carton Sealing Tape - Imprinted Legends... with ACRYLIC WATER BASED ADHESIVE



**PP20F-W... FRAGILE on White Film**  
 2.0 mil (0.055mm). 30µ film. **Water based acrylic adhesive.** One (1) color printing: red text on WHITE film. 3" neutral core/carton.

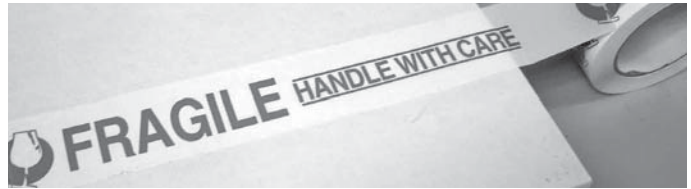

WIDTH x LENGTH		RLS/CS	CASES		
			1-5	6-18	19+
<b>FRAGILE HANDLE WITH CARE</b>					
2" (48mm)	x 110 yd	36			



**PP20W-C... WARNING/AVISO on Clear Film or PP20W-W... WARNING/AVISO on White Film**  
 2.0 mil (0.055mm). 30µ film. **Water based acrylic adhesive.** One (1) color printing: Red text on CLEAR or WHITE film. 3" neutral core/carton.



Specify **PP20W-C** (clear film) or **PP20W-W** (white film) when ordering.

WIDTH x LENGTH		RLS/CS	CASES		
			1-5	6-18	19+
<b>WARNING / AVISO</b>					
2" (48mm)	x 110 yd	36			

Alternative to IPG #321CP; STA #124x.



**PP20S-C... STOP/CHECK on Clear Film or PP20S-W... STOP/CHECK on White Film**  
 2.0 mil (0.055mm). 30µ film. **Water based acrylic adhesive.** Two (2) color printing: Red & black text on CLEAR or WHITE film. 3" neutral core/carton.



Specify **PP20S-C** (clear film) or **PP20S-W** (white film) when ordering.

WIDTH x LENGTH		RLS/CS	CASES		
			1-5	6-18	19+
<b>STOP CHECK CONTENTS (2" Pattern)</b>					
2" (48mm)	x 110 yd	36			
2" (48mm)	x 1000 yd	6			

Alternative to 3M #3771; IPG #3215P; STA #124x; Achem #12B.



**PP20S-C... STOP/CHECK on Clear Film or PP20S-T... STOP/CHECK on Tan Film**  
 2.0 mil (0.055mm). 30µ film. **Water based acrylic adhesive.** Two (2) color printing: Red & black text on CLEAR or TAN film. 3" neutral core/carton.



Specify **PP20S-C** (clear film) or **PP20S-T** (tan film) when ordering.

WIDTH x LENGTH		RLS/CS	CASES		
			1-5	6-18	19+
<b>STOP CHECK CONTENTS (3" Pattern)</b>					
3" (72mm)	x 110 yd	24			
3" (72mm) *	x 1000 yd	4			

\*Tan film ONLY (3" x 1000 yd is not available in clear).

Alternative to 3M #3771; IPG #3215P; STA #124x.

Custom printed tapes are available. Please call / e-mail us for product information and pricing.

# Custom Printed Tapes...

## Terms, Options, and Additional Charges:

### 17 Stock Ink Colors:

White	Green 347	Pantone Purple
Gray 5	Lime Green 368	Pantone Violet
Red 186	Reflex Blue	Maroon 201
Orange 021	Process Blue	Brown 469
Yellow 102	Teal 321	Gold 132
Black	Navy 281	

\*PMS colors (3+ case minimum): Add 25% per color

\*Floodcoats (or >50% ink coverage):

Call for Quote (minimums may apply)

\*Priced for 1 color; for additional colors:

2 ink colors (2 case minimum): Add 15% to base price

3 ink colors (5 case minimum): Add 30% to base price

### Colored Films (for 2.0 mil Acrylic only):

Red	Yellow	Blue	Pink
Orange	Green	Black	

\*Add 40% to base price for Colored Films.

### Art & Plate Charges:

- One time plate: (1st color);  
+ for additional ink plates.
- Plates are property of printer.
- Must be vector art or artwork charges may apply at /hr (1 hour minimum).
- Printing plates will be kept on file for 3 years; if not reordered in that time limit, the plate will be purged.

### Minimum Order:

- 1 ink color jobs: 1 case (unless otherwise indicated)
- 2 ink color jobs: 2 cases
- 3 ink color jobs: 5 cases
- Custom PMS color(s): 3+ cases (please confirm with colors)

### Lead Time:

After all approvals have been received, allow approximately 5 weeks before shipping.

### Other Conditions of Sale:

- Price is F.O.B. Miami. Transportation charges are prepaid and allowed to destination on custom print orders of invoice value or more, within contiguous United States via lowest cost routing. **Custom printed tape orders cannot be combined with stock orders.**
- We reserve the right to ship  $\pm$  15%.
- Partial cases must be accepted.
- Print legend height is approximately 1-5/8" for 2" wide tapes, 2-5/8" for 3" wide tapes. Legend length is an approx. 10 1/2" pattern - with usually a 1/2"-3/4" space between legends. If legend is less than 10 1/2" - extra space will result.

**Custom Printed Tapes are  
NON-CANCELABLE & NON-RETURNABLE.**

Please call or e-mail us for the current Custom Printed Tapes Product Information & Pricing Packet, as changes may occur without notice.

NOTE: All items are PRICED PER ROLL based on ONE STOCK INK COLOR.

ITEM SIZE	R/C	1 case	2-10	11-26	27-50
<b>OPP- CP - Custom Printed Polypropylene Tape</b>					
2.0 Mil Clear, Tan or White Tape with					
Acrylic Water Based Adhesive OR Hot Melt Rubber Adhesive					
3/4" (18mm) x 60 yds		144			
1" (24mm) x 60 yds		96			
1.5" (36mm) x 60 yds		48			
2" (48mm) x 55 yds		72			
2" (48mm) x 110 yds		36			
2" (48mm) x 1000 yds		6			
3" (72mm) x 55 yds		48			
3" (72mm) x 110 yds		24			
3" (72mm) x 1000 yds		4			
2.5 Mil Clear or White Tape with Hot Melt Rubber Adhesive OR					
2.4 Mil Clear, Tan or White with Acrylic Water Based Adhesive (11 case minimum)					
2" (48mm) x 110 yds		36			
2" (48mm) x 1000 yds		6			
3" (72mm) x 55 yds		48			
3" (72mm) x 110 yds		24			
3" (72mm) x 1000 yds		4			
3.0 Mil Clear or White Tape with Hot Melt Rubber Adhesive OR					
3.2 Mil Clear, Tan or White with Acrylic Water Based Adhesive (11 case minimum)					
2" (48mm) x 55 yds		72			
2" (48mm) x 110 yds		36			
2" (48mm) x 1000 yds		6			Acrylic Adh. ONLY (11+ cases)
3" (72mm) x 55 yds		48			
3" (72mm) x 110 yds		24			
For volume quotes on printed polypropylene tapes with acrylic adhesive, please call or email with your requirements.					
<b>UPVC- CP - Custom Printed UPVC Tape</b>					
2.2 Mil White, Tan, or Clear with Solvent Based Natural Rubber Adhesive					
2" (48mm) x 55 yds		72			
2" (48mm) x 110 yds		36			
3" (72mm) x 55 yds		48			
3" (72mm) x 110 yds		24			
<b>WAT- CP - Custom Printed Water Activated Gummed Tape</b>					
<b>Gummed Side Out (GSO):</b> Light duty 40# paper tape recommended for sealing delicatessen and butcher wrap, retail gift wrap, and carry-out packages. Wound onto 1" cores.					
1" (24mm) x 500 ft	White	30			
1.5" (36mm) x 500 ft	White	20			
<b>WAT-160CP:</b> Printed Non-Reinforced 57# gummed tape; recommended for sealing lightweight cartons, as a dust seal for in-plant use.					
3" (72mm) x 600 ft	Kraft	10			
<b>WAT-240CP:</b> Reinforced paper for average weight cartons, up to 30lbs. 46# paper with 5-way bi-directional fiberglass reinforcements.					
3" (72mm) x 375 ft	Kraft	8			
3" (72mm) x 450 ft	Kraft	10			
3" (72mm) x 450 ft	White	10			
3" (72mm) x 500 ft	Kraft	6			
3" (72mm) x 500 ft	White	6			
<b>WAT-260CP:</b> Reinforced paper for heavier boxes, double wall, overstuffed & recycled ctns, up to 55lbs. 50# paper with 5-way double strand bi-directional fiberglass reinforcements.					
3" (72mm) x 450 ft	Kraft	10			
3" (72mm) x 500 ft	Kraft	6			

"Locked-In" BOPP Custom Printing & Custom Printed Tamper Evident Tape also available. Contact us for details!

# Polypropylene Carton Sealing Tapes...

with ACRYLIC WATER BASED ADHESIVE

## OPP-16AW... CLEAR & BROWN

1.6 mil (0.040mm). 23 micron film. **Water Based Acrylic Adhesive.**  
Peel Adhesion: 16 oz/in. Tensile: 11 lbs/in. Elongation: 180%.  
3" TalonTape core/carton.

49" (1260mm) x 4000M Jumbos Available.

## OPP-18AW... CLEAR & BROWN

1.8 mil (0.045mm). 25 micron film. **Water Based Acrylic Adhesive.**  
Peel Adhesion: 18 oz/in. Tensile: 16 lbs/in. Elongation: 180%.  
Temp. Resistance: 32°F to 140°F. 3" TalonTape core/carton.

49" (1260mm) x 4000M Jumbos Available.

Alternative to 3M #305; American #321; IPG #300; Shurtape #PP-810; STA #1170;  
R-2#179; Taratape #35; Cantech #257; Achem #CS17; Berry Global #818.

## OPP-20AW... CLEAR & BROWN

2.0 mil (0.050mm). 28 micron film. **Water Based Acrylic Adhesive.**  
Peel Adhesion: 22 oz/in. Tensile: 18 lbs/in. Elongation: 180%.  
Temp. Resistance: 32°F to 140°F. 3" TalonTape core/carton.

49" (1260mm) x 4000M Jumbos Available.

Alternative to 3M #311; American #124; IPG #400; STA #1182, R-2#183; Cantech #259;  
Taratape #38P; Achem #CS20A; Shurtape #PP-802; Berry Global #183.

WIDTH	RLS/CS	CASES		
		1-11	12-24	25+
<b>1000 YD (914M)</b>				
3/4"	† (18mm)	16		
1"	† (24mm)	12		
1.5"	† (36mm)	8		
2"	(48mm)	6		
3"	(72mm)	4		
† Clear Only.				
<b>1500 YD (1371M) CLEAR ONLY</b>				
2"	(48mm)	6		
3"	(72mm)	4		
<b>2000 YD (1828M) CLEAR ONLY</b>				
2"	(48mm)	6		
3"	(72mm)	4		

## OPP-26AW... CLEAR

2.6 mil (0.065mm). 38 micron film. **Water Based Acrylic Adhesive.**  
Peel Adhesion: 22 oz/in. Tensile: 27 lbs/in. Elongation: 180%.  
Temp. Resistance: 32°F to 140°F. 3" TalonTape core/carton.

49" (1260mm) x 3000M Jumbos Available.

Alternative to 3M #313; IPG #291; Central #420; STA #1352; Taratape #65;  
Achem #CS26A; Shurtape #PP-815 & #AP401; Berry Global #266.

WIDTH	RLS/CS	CASES		
		1-11	12-24	25+
<b>1000 YD (914M) CLEAR ONLY</b>				
2"	(48mm)	6		
3"	(72mm)	4		



WIDTH	RLS/CS	CASES		
		1-11	12-24	25+
<b>55 YD (50M)</b>				
2"	(48mm)	36		

WIDTH	RLS/CS	CASES		
		1-11	12-24	25+
<b>110 YD (100M)</b>				
2"	(48mm)	36		
3"	(72mm)	24		

WIDTH	RLS/CS	CASES		
		1-11	12-24	25+
<b>55 YD (50M)</b>				
2"	(48mm)	36		
3"	(72mm)	24		

WIDTH	RLS/CS	CASES		
		1-11	12-24	25+
<b>110 YD (100M)</b>				
2"	(48mm)	36		
3"	(72mm)	24		

WIDTH	RLS/CS	CASES		
		1-11	12-24	25+
<b>220 YD (201M)</b>				
2"	(48mm)	36		

WIDTH	RLS/CS	CASES		
		1-11	12-24	25+
<b>1000 YD (914M) CLEAR ONLY</b>				
2"	(48mm)	6		
3"	(72mm)	4		

WIDTH	RLS/CS	CASES		
		1-11	12-24	25+
<b>55 YD (50M)</b>				
3/8"	(9mm)	192		
1/2"	(12mm)	144		
3/4"	(18mm)	96		
1"	(24mm)	72		
1.5"	(36mm)	48		
2"	* (48mm)	36		
3"	(72mm)	24		
4"	(96mm)	18		
6"	(144mm)	12		
49"	(1260mm)	LOG		

WIDTH	RLS/CS	CASES		
		1-11	12-24	25+
<b>110 YD (100M)</b>				
3/8"	(9mm)	192		
1/2"	(12mm)	144		
3/4"	(18mm)	96		
1"	* (24mm)	72		
1.5"	(36mm)	48		
2"	* (48mm)	36		
3"	* (72mm)	24		
4"	(96mm)	18		
4.75"	(120mm)	18		
49"	(1260mm)	LOG		

\* Lower proportional price, as stocked pre-slit.

WIDTH	RLS/CS	CASES		
		1-11	12-24	25+
<b>55 YD (50M) CLEAR ONLY</b>				
3/8"	(9mm)	192		
1/2"	(12mm)	144		
3/4"	(18mm)	96		
1"	(24mm)	72		
1.5"	(36mm)	48		
2"	(48mm)	36		
3"	(72mm)	24		
4"	(96mm)	18		
6"	(144mm)	12		
49"	(1260mm)	LOG		

WIDTH	RLS/CS	CASES		
		1-11	12-24	25+
<b>110 YD (100M) CLEAR ONLY</b>				
3/8"	(9mm)	192		
1/2"	(12mm)	144		
3/4"	(18mm)	96		
1"	(24mm)	72		
1.5"	(36mm)	48		
2"	(48mm)	36		
3"	(72mm)	24		
4"	(96mm)	18		
6"	(144mm)	12		
49"	(1260mm)	LOG		

\* Lower proportional price, as stocked pre-slit.

# Polypropylene Carton Sealing Tapes...

with ACRYLIC WATER BASED ADHESIVE

## OPP-32AW... CLEAR, DARK TAN & WHITE

3.2 mil (0.080mm). 48 micron film. **Water Based Acrylic Adhesive.** Premium grade, high strength, biaxially oriented polypropylene film. Designed for demanding packaging requirements. Peel Adhesion: 22 oz/in. Tensile Strength: 32 lbs/in. Elongation: 180%. Temp. Resistance: 32°F to 140°F. 3" TalonTape core/carton.

49" (1260mm) x 2000M Jumbos Available.

WIDTH	RLS/CS	CASES		
		1-11	12-24	25+
<b>72 YD (66M)</b>				
1/2"	(12mm)	144		
3/4"	(18mm)	96		
1"	(24mm)	72		
1.5"	(36mm)	48		
<b>2"</b>	<b>* (48mm)</b>	<b>36</b>		
<b>3"</b>	<b>* (72mm)</b>	<b>24</b>		
4"	(96mm)	18		
49"	(1260mm)	LOG		

\* Pre-slit, not proportional. Alternative to IPG #341; STA #1535.

# Polypropylene Carton Sealing Tapes...

ACRYLIC SOLVENT BASED ADHESIVE

## OPP-22CC... CRYSTAL CLEAR

2.2 mil (0.055mm). 28 micron film. A biaxially oriented polypropylene tape, coated with a **solvent based acrylic adhesive.** Adhesion: 27 oz/in. Tensile: 20 lbs/in. Elongation at break: 140%. Temp. Resistance: 32°F to 140°F. See-through "CRYSTAL CLEAR" imprinted on 3" core. Crystal clear tape is non-yellowing & UV resistant with long shelf life and no fish eyes. Used for lamination and carton sealing. May also be used in cold temperature applications. Meets spec A-A-1684C.

\* Lower proportional cost, as stocked pre-slit.

Alternative to Shurtape #PP803; Achem #CC22 & #12T.



<b>55 YD (50M)</b>				
3/8"	(9mm)	192		
1/2"	(12mm)	144		
3/4"	(18mm)	96		
<b>1"</b>	<b>* (24mm)</b>	<b>72</b>		
1.5"	(36mm)	48		
<b>2"</b>	<b>* (48mm)</b>	<b>36</b>		
<b>3"</b>	<b>* (72mm)</b>	<b>24</b>		
4"	(96mm)	18		
49"	(1260mm)	LOG		neutral core

<b>110 YD (100M)</b>				
3/8"	(9mm)	192		
1/2"	(12mm)	144		
3/4"	(18mm)	96		
<b>1"</b>	<b>* (24mm)</b>	<b>72</b>		
1.5"	(36mm)	48		
<b>2"</b>	<b>* (48mm)</b>	<b>36</b>		
3"	(72mm)	24		
4"	(96mm)	18		
49"	(1260mm)	LOG		neutral core

## OPP-26CC... CRYSTAL CLEAR

2.7 mil (0.068mm). 40 micron film. A biaxially oriented polypropylene tape, coated with a solvent based acrylic adhesive. Adhesion: 30 oz/in. Tensile: 24 lbs/in. Elongation at break: 140%. Temp. Resistance: 32°F to 140°F. See-through "CRYSTAL CLEAR" imprinted on 3" core. Crystal clear tape is non-yellowing & UV resistant with long shelf life and no fish eyes. Used for moderate demand lamination and carton sealing applications. May also be used in cold temperature applications. Meets spec A-A-1684C.

\* Lower proportional cost, as stocked pre-slit.

Alternative to Achem #12W.



<b>55 YD (50M)</b>				
3/8"	(9mm)	192		
1/2"	(12mm)	144		
3/4"	(18mm)	96		
1"	(24mm)	72		
1.5"	(36mm)	48		
<b>2"</b>	<b>* (48mm)</b>	<b>36</b>		
<b>3"</b>	<b>* (72mm)</b>	<b>24</b>		
<b>4"</b>	<b>* (96mm)</b>	<b>18</b>		
49"	(1260mm)	LOG		neutral core

<b>110 YD (100M)</b>					
3/8"	(9mm)	192	\$1.23	\$1.13	\$1.05
1/2"	(12mm)	144	1.55	1.43	1.33
3/4"	(18mm)	96	2.22	2.04	1.90
<b>1"</b>	<b>* (24mm)</b>	<b>72</b>	<b>2.31</b>	<b>2.13</b>	<b>1.98</b>
1.5"	(36mm)	48	4.20	3.86	3.59
<b>2"</b>	<b>* (48mm)</b>	<b>36</b>	<b>4.50</b>	<b>4.14</b>	<b>3.85</b>
3"	(72mm)	24	8.17	7.52	6.99
<b>4"</b>	<b>* (96mm)</b>	<b>18</b>	<b>9.05</b>	<b>8.32</b>	<b>7.74</b>
49"	(1260mm)	LOG		neutral core	99.50

## OPP-34CC... CRYSTAL CLEAR

3.6 mil (0.09mm). 60 micron film. A biaxially oriented polypropylene tape, coated with a solvent based acrylic adhesive Adhesion: 30 oz/in. Tensile: 38 lbs/in. Elongation at break: 180%. Temp. Resistance: 32°F to 140°F. See-through "CRYSTAL CLEAR" imprinted on 3" core. Crystal clear tape is non-yellowing & UV resistant with long shelf life and no fish eyes. Used for moderate demand lamination and carton sealing applications. May also be used in cold temperature applications.

\* Lower proportional cost, as stocked pre-slit.

<b>55 YD (50M)</b>				
3/8"	(9mm)	192		
1/2"	(12mm)	144		
<b>3/4"</b>	<b>* (18mm)</b>	<b>96</b>		
<b>1"</b>	<b>* (24mm)</b>	<b>72</b>		
<b>1.5"</b>	<b>* (36mm)</b>	<b>48</b>		
<b>2"</b>	<b>* (48mm)</b>	<b>36</b>		
<b>3"</b>	<b>* (72mm)</b>	<b>24</b>		
<b>4"</b>	<b>* (96mm)</b>	<b>18</b>		
12"	(300mm)	6		
49"	(1260mm)	LOG		neutral core

Alternative to Achem #12X.

# Polypropylene Carton Sealing Tapes...

with ACRYLIC SOLVENT BASED ADHESIVE



## OPP-20A... CLEAR

1.9 mil (0.049mm). 25 micron film. Biaxially oriented polypropylene tape with **solvent based acrylic adhesive**. Adhesion: 21 oz/in. Tensile: 15 lbs/in. Elongation: 140%. Temperature Resistance: -4°F to 158°F. 3" neutral core/carton.

63" (1605mm) x 4000M Jumbos Available.

## OPP-22A... CLEAR & TAN

2.1 mil (0.054mm). 28 micron film. Biaxially oriented polypropylene tape with **solvent based acrylic adhesive**. Adhesion: >23 oz/in. Tensile: >20 lbs/in. Elongation: 140%. Temperature Resistance: -4°F to 158°F. 3" neutral core/carton.

49" (1260mm) x 4000M Jumbos Available.

\* Lower proportional cost, as stocked pre-slit.

## OPP-26A... CLEAR

2.6 mil (0.066mm). 40 micron film. Biaxially oriented polypropylene tape with **solvent based acrylic adhesive**. Excellent balance of adhesion and tensile strength for heavy weight carton sealing applications. Adhesion: >25 oz/in. Tensile: >26 lbs/in. Elongation: 140%. Temperature Resistance: -4°F to 158°F. Meets SPEC A-A-1684C. 3" neutral core/carton.

49" (1260mm) x 3000M Jumbos Available.

\* Lower proportional cost, as stocked pre-slit.

† NOTE: 2"(48mm) x 55Yd also stocked in TAN.

## OPP-34A... CLEAR & TAN

3.5 mil (0.089mm). 60 micron film. Biaxially oriented polypropylene tape with PREMIUM GRADE **solvent based acrylic adhesive**. Its strong adhesion to cardboard and high tensile strength make it ideal for extremely demanding packaging needs. Adhesion: >28 oz/in. Tensile: >37 lbs/in. Elongation: 140%. Temperature Resistance: -4°F to 158°F. 3" neutral core/carton.

49" (1260mm) x 2000M Jumbos Available.

\* Lower proportional cost, as stocked pre-slit.

WIDTH	RLS/CS	CASES		
		1-11	12-24	25+
<b>110 YD (100M)</b>				
3/8"	(9mm)	192		
1/2"	(12mm)	144		
3/4"	(18mm)	96		
1"	(24mm)	72		
1.5"	(36mm)	48		
2"	(48mm)	36		
3"	(72mm)	24		
4"	(96mm)	18		
63"	(1605mm)	LOG		neutral core

<b>55 YD (50M)</b>				
3/8"	(9mm)	192		
1/2"	(12mm)	144		
3/4"	(18mm)	96		
1"	(24mm)	72		
1.5"	(36mm)	48		
2"	* (48mm)	36		
3"	(72mm)	24		
4"	(96mm)	18		
49"	(1260mm)	LOG		neutral core

<b>110 YD (100M)</b>				
3/8"	(9mm)	192		
1/2"	(12mm)	144		
3/4"	(18mm)	96		
1"	* (24mm)	72		
1.5"	(36mm)	48		
2"	* (48mm)	36		
3"	* (72mm)	24		
4"	(96mm)	18		
49"	(1260mm)	LOG		neutral core

Alternative to Achem #AS22 & #122; Shurtape #PP-802; Berry Global #730.

<b>55 YD (50M)</b>				
3/8"	(9mm)	192		
1/2"	(12mm)	144		
3/4"	(18mm)	96		
1"	(24mm)	72		
1.5"	(36mm)	48		
2"	† * (48mm)	36		
3"	* (72mm)	24		
4"	* (96mm)	18		
49"	(1260mm)	LOG		neutral core

<b>110 YD (100M)</b>				
3/8"	(9mm)	192		
1/2"	(12mm)	144		
3/4"	(18mm)	96		
1"	* (24mm)	72		
1.5"	(36mm)	48		
2"	* (48mm)	36		
3"	(72mm)	24		
4"	(96mm)	18		
49"	(1260mm)	LOG		neutral core

Alternative to Shurtape #PP815; Achem #AS26 & #123; Permaceal #P-915.

<b>55 YD (50M)</b>				
3/8"	(9mm)	192		
1/2"	(12mm)	144		
3/4"	(18mm)	96		
1"	(24mm)	72		
1.5"	(36mm)	48		
2"	* (48mm)	36		
3"	* (72mm)	24		
4"	(96mm)	18		
12"	(300mm)	6		
49"	(1260mm)	LOG		neutral core

Alternative to IPG #341; STA #1535; Achem #AS36 & #124; Permaceal #P-919.

# Colored Polypropylene Carton Sealing Tapes...

with ACRYLIC ADHESIVE

## OPP-20C... COLORS

2.0 mil (0.048mm). 28 micron film. **Water Based Acrylic Adhesive.** Used for carton sealing, color coding & identification. Peel Adhesion: 22 oz/in. Tensile Strength: 18 lbs/in. Elongation: 180%. Temperature Range: 32°F to 150°F. 3" neutral core/carton.

**9 BRIGHT SHINY COLORS:** White, black, yellow, orange, red, blue, green, pink & purple.

49" (1260mm) x 4000M Jumbos Available.

Alternative to IPG #321C & #410; Cantech #261; Achem #CS20C; Taratape #38; 3M #311 & #371; STA #1159.

### 1000 YD (914M)

2"	(48mm)	6
3"	(72mm)	4

### 2000 YD (1828M) RED ONLY

2"	(48mm)	6
----	--------	---

## OPP-22C... COLORS

2.2 mil (0.055mm). 28 micron film. **Solvent Based Acrylic Adhesive.** Used for carton sealing, color coding, splicing and identification. Adhesion to SST: 27 oz/in. Tensile Strength: 20 lbs/in. Elongation: 140%. Temperature Range: 32°F to 150°F. 3" neutral core/carton.

**7 BRIGHT SHINY COLORS:** White, black, yellow, orange, red, blue & green.

49" (1260mm) x 4000M Jumbos Available.

Alternative to Achem #122; Berry Global #730 Red.

\*Lower proportional cost as stocked pre-slit.

## OPP-26CAW... COLORS

2.6 mil (0.065mm). 38 micron film. **Water Based Acrylic Adhesive.** Peel Adhesion: 22 oz/in. Tensile: 27 lbs/in. Elongation: 180%. Temp. Range: 32°F to 140°F. 3" neutral core/carton.

**6 BRIGHT SHINY COLORS:** White, red, green, orange, yellow & blue.

(Other colors available as special order.)

## OPP-26C... COLORS

2.6 mil (0.066mm). 40 micron film. **Solvent Based Acrylic Adhesive.** High quality adhesive and strong film makes this tape an excellent choice for demanding carton sealing, splicing and color coding applications. Adhesion to SST: 25 oz/in. Tensile: 26 lbs/in. Elongation: 140%. Temp. Resistance: 32°F to 150°F. 3" neutral core/carton.

**5 BRIGHT SHINY COLORS:** White, yellow, red, blue & green.

49" (1260mm) x 3000M Jumbos Available.

WIDTH	RLS/CS	CASES		
		1-11	12-24	25+
<b>55 YD (50M)</b>				
3/8"	(9mm)	192		
1/2"	(12mm)	144		
3/4"	(18mm)	96		
1"	(24mm)	72		
1.5"	(36mm)	48		
2"	* (48mm)	36		
3"	(72mm)	24		
4"	(96mm)	18		
49"	(1260mm)	LOG		neutral core

WIDTH	RLS/CS	CASES		
		1-11	12-24	25+
<b>110 YD (100M)</b>				
3/8"	(9mm)	192		
1/2"	(12mm)	144		
3/4"	(18mm)	96		
1"	(24mm)	72		
1.5"	(36mm)	48		
2"	* (48mm)	36		
3"	* (72mm)	24		
4"	(96mm)	18		
49"	(1260mm)	LOG		neutral core

\* Lower proportional price, as stocked pre-slit.

WIDTH	RLS/CS	CASES		
		1-11	12-24	25+
<b>55 YD (50M)</b>				
3/8"	(9mm)	192		
1/2"	(12mm)	144		
3/4"	(18mm)	96		
1"	(24mm)	72		
1.5"	(36mm)	48		
2"	(48mm)	36		
3"	(72mm)	24		
4"	(96mm)	18		
49"	(1260mm)	LOG		neutral core

WIDTH	RLS/CS	CASES		
		1-11	12-24	25+
<b>110 YD (100M)</b>				
3/8"	(9mm)	192		
1/2"	(12mm)	144		
3/4"	(18mm)	96		
1"	(24mm)	72		
1.5"	(36mm)	48		
2"	* (48mm)	36		
3"	(72mm)	24		
4"	(96mm)	18		
49"	(1260mm)	LOG		neutral core

WIDTH	RLS/CS	CASES
2"	(48mm)	36

WIDTH	RLS/CS	CASES
2"	(48mm)	6

49" (1260mm) x 3000M Jumbos Available.

WIDTH	RLS/CS	CASES		
		1-11	12-24	25+
<b>72 YD (66M)</b>				
3/8"	(9mm)	192		
1/2"	(12mm)	144		
3/4"	(18mm)	96		
1"	(24mm)	72		
1.5"	(36mm)	48		
2"	* (48mm)	36		
2.5"	(60mm)	30		
3"	(72mm)	24		
4"	(96mm)	18		
49"	(1260mm)	LOG		neutral core

Alternative to Achem #123; 3M #373.

\* Lower proportional price, as stocked pre-slit.

# Polypropylene Carton Sealing Tapes...

with HOT MELT RUBBER BASED ADHESIVE (recommended for initial quick stick)

## OPP-16HM... Economy Grade

1.6mil (0.041mm). 25 micron Cast film with Hot Melt/Synthetic Rubber Resin Adhesive. Adhesion: 30 oz/in. Tensile: 17.6 lbs/in (machine direction); 34 lbs/in (cross direction). Elongation 110%. 3" neutral core.

WIDTH	RLS/CS	CASES		
		1-11	12-24	25+
55 YD (50M) CLEAR & TAN				
2"	(48mm)	36		
110 YD (100M) CLEAR				
3"	(72mm)	24		
110 YD (100M) CLEAR				
2"	(48mm)	36		
1000 YD (914M) CLEAR				
2"	(48mm)	6		

## OPP-18HM... Industrial Grade **CLOSEOUT**

1.8mil (0.046mm). 27 micron Cast film with Hot Melt/Synthetic Rubber Adhesive. Adhesion: 32 oz/in. Tensile: 27 lbs/in Elongation 70%. Meets ASTM D3330, ASTM D3654, ASTM D3759, PSTC-16. 3" neutral core.

# Polypropylene Carton Sealing Tapes...

with NATURAL RUBBER BASED ADHESIVE (recommended for recycled cartons & cold temperature application)

## OPP-18NR... Clear

1.80 mil (0.045mm). 25 micron film. **Solvent Based Natural Rubber Adhesive.** Tensile: 21 lbs/in. Adhesion to steel: 22 oz/in. Elongation: 170%. Application Temperature Range: 0°F to 150°F. 3" neutral core.

WIDTH	RLS/CS	CASES		
		1-11	12-24	25+
55 YD (50M)				
2"	(48mm)	36		
110 YD (100M)				
2"	(48mm)	36		
3"	(72mm)	24		
1000 YD (914M)				
2"	(48mm)	6		

Alternative to IPG #500; STA #1580; Cantech #253.

## OPP-20NR... Clear

2.0 mil (0.048mm). 28 micron film. **Solvent Based Natural Rubber Adhesive.** Tensile: 23 lbs/in. Adhesion to Steel: 22 oz/in. Elongation: 170%. Application Temperature Range: 0°F to 150°F. 3" neutral core.

110 YD (100M)				
1.5"	(36mm)	48		
2"	(48mm)	36		
3"	(72mm)	24		
1000 YD (914M)				
3"	(72mm)	4		
6"	(144mm)	2		

Alternative to IPG #500 & #530; STA #1582; Achem #CS20NR.

## OPP-26NR... Clear

2.5 mil (0.062mm). 40 micron film. **Solvent Based Natural Rubber Adhesive.** Tensile: 30 lbs/in. Adhesion to Steel: 20 oz/in. Elongation: 190%. Application Temperature Range: 0°F to 150°F. 3" neutral core.

55 YD (50M)				
2"	(48mm)	36		
110 YD (100M)				
2"	(48mm)	36		
3"	(72mm)	24		
1000 YD (914M)				
2"	(48mm)	6		
3"	(72mm)	4		

Alternative to IPG #510 & #520; Achem #CS25NR.

# Polyester Carton Sealing Tape...

## PES-32G... Clear

3.0 mil total thickness. 50 micron heavy-duty polyester film with an aggressive hot melt adhesive. High quality, high performance packaging, sealing, and splicing tape. Superior adhesive properties to insure instant holding power. Provides a quick reliable seal when used for strip closure of regular slotted containers, overlap sealing, and fiber drum sealing. Adhesion: 65 oz/in. Tensile: 55 lbs/in. Elongation: 100%. Temp. Range: -10°F to 140°F. Meets ASTM D5486, Type II, Class 2 (replaces PPP-T-60E, A-A-1830); A-A-1684C (replaces A-A-1684B, PPP-T-70). 3" neutral core.

59" (1500mm) x 3500M Jumbos Available.

WIDTH	RLS/CS	CASES		
		1-5	6-12	13+
60 YD (55M)				
1"	(25.4mm)	72		
1.5"	(38.1mm)	48		
2"	(50.8mm)	36		
3"	(76.2mm)	24		
59"	(1500mm)	LOG		neutral core

Alternative to Permaccel #P-929; Bemis #BT-41; Cantech #0228; IPG #780; 3M #351 (clear), #375.



# UPVC Carton Sealing Tapes (Packaging)...

with NATURAL RUBBER BASED ADHESIVE (recommended for recycled cartons & cold temperature application)

## UPVC-22... Packaging

2.2 mil. 32 micron UPVC film. Solvent based natural rubber adhesive. Quiet unwind. Excellent quality carton sealing tape. Printable & heat-shrinkable. Adhesion: 15 oz/in. Tensile: 42 lbs/in. Elongation: 75%. Temp. Resistance: 158°F. 3" neutral core.

**3 COLORS AVAILABLE: White, clear & tan.**

Master Jumbos Available.

NOTE: 6" and 12" PRINTER rolls available. See page 30 for details. Call for pricing.

WIDTH	RLS/CS	CASES		
		1-9	10-24	25+

55 YD (50M)				
1/2"	(12mm)	144		
3/4"	(19mm)	96		
1"	(25mm)	72		
1.5"	(38mm)	48		
2"	* (48mm)	36		
3"	* (75mm)	24		
53"	(1350mm)	LOG		neutral core

110 YD (100M)				
3/4"	(19mm)	96		
1"	(25mm)	72		
1.5"	* (36mm)	48		
2"	* (48mm)	36		
3"	* (75mm)	24		
4"	(96mm)	18		
53"	(1350mm)	LOG		neutral core

Alternative to Tesa #4120; NOPI #4085; IPG #530; Monta #281/220; STA #1263; Shurtape #VF719; 3M #690; Achem #CS22U.

\* Lower proportional price, as stocked pre-slit.

## UPVC-24... Medium Grade

2.4 mil. 35 micron UPVC film. Solvent based natural rubber adhesive. For medium duty carton/can sealing. Printable & heat shrinkable. Adhesion: 15 oz/in. Tensile: 42 lbs/in. Elongation: 75%. Temp. Resistance: 158°F. 3" neutral core.

**2 COLORS AVAILABLE: Clear & tan.**

72 YD (66M)				
1/2"	(12mm)	144		
3/4"	(19mm)	96		
1"	(25mm)	72		
1.5"	(38mm)	48		
2"	(48mm)	36		
3"	(72mm)	24		
4"	(96mm)	18		
53"	(1350mm)	LOG		neutral core

Alternative to Tesa #4124; 3M #6811.

## UPVC-24C... Colors

2.4 mil. 35 micron UPVC film. Solvent based natural rubber adhesive. Used as block-out for screen printers and for color coding, splicing, carton/can sealing & bundling. Printable & heat shrinkable. Adhesive is white. Adhesion: 15 oz/in. Tensile: 42 lbs/in. Elongation: 75%. Temp. Resistance: 158°F. 3" neutral core.

**9 COLORS AVAILABLE: Black, white, red, dark blue, light blue, dark green, light green, orange & yellow.**

**8 BOOKBINDING COLORS AVAILABLE: Black, red, dark blue, light blue, dark green, light green, orange & yellow.**

Master Jumbos Available.

NOTE: 6" and 12" PRINTER rolls available - See page 30 for details. Call for pricing.

72 YD (66M)				
1/2"	(12mm)	144		
3/4"	(19mm)	96		
1"	* (25mm)	72		
1.5"	* (38mm)	48		
2"	* (48mm)	36		
3"	(72mm)	24		
4"	(96mm)	18		
53"	(1350mm)	LOG		neutral core

110 YD (100M) RED ONLY				
2"	(48mm)	36		

1000 YD (914M) BOOKBINDING TAPE				
1.5"	(38mm)	8		

Alternative to Tesa #4104 & #4124; IPG #600; Scapa # 2210; 3M #690 Paklon; Achem #CS24U & #PV24; Shurtape #PP808.

\* Lower proportional price, as stocked pre-slit.

## UPVC-25F... Fluorescent Orange

2.5 mil. 39 micron UPVC film. Solvent based natural rubber adhesive. For color coding, carton/can sealing, bundling. Printable & heat shrinkable. Adhesion: 15 oz/in. Tensile: 42 lbs/in. Elongation: 90%. Temp. Resistance: 158°F. 3" neutral core.

NOTE: 6" PRINTERS rolls available - See page 30 for details. Call for pricing.

Master Jumbos Available.

72 YD (66M)				
3/8"	(9mm)	192		
1/2"	(12mm)	144		
3/4"	(18mm)	96		
1"	* (25mm)	72		
1.5"	* (38mm)	48		
2"	* (48mm)	36		
3"	(72mm)	24		
4"	(96mm)	18		
53"	(1350mm)	LOG		neutral core

\* Lower proportional price, as stocked pre-slit.

# UPVC Bag Sealing/Produce Tapes...

## UPVC-22BS...

2.2 mil. 32 micron UPVC Film. Solvent Based Natural Rubber Adhesive. Used for produce packaging, can sealing or bundling. Printable. Adhesion: 15 oz/in. Tensile: 42 lbs/in. Elongation: 75%. Temperature Resistance: 176°F. 3" neutral core/carton.

Alternative to Tesa #4204; 3M #690; Cantech #222; Achem #BS22 & #BS24.

## UPVC-24BS...

2.4 mil. 35 micron UPVC Film. Solvent Based Natural Rubber Adhesive. Seals polyethylene and other film bags swiftly and efficiently when used in a bag sealing dispenser. Used for color coding age of perishables. Printable. Adhesion: 15 oz/in. Tensile: 42 lbs/in. Elongation: 75%. Temperature Resistance: 176°F. 3" neutral core/carton.

See page 70 for bag seal dispensers.

WIDTH	RLS/CS	CASES		
		1-6	7-11	12+
3/8" (9MM) x 180 YD (165M)				
3/8"	(9mm) 96			
<b>3 COLORS AVAILABLE: White, clear &amp; tan.</b>				
1/2" (12MM) x 180 YD (165M) WHITE ONLY				
1/2"	(12mm) 72			

WIDTH	RLS/CS	CASES		
		1-6	7-11	12+
3/8" (9MM) x 180 YD (165M)				
3/8"	(9mm) 96			
<b>8 COLORS AVAILABLE: Black, dark blue, light blue, dark green, light green, orange, red &amp; yellow.</b>				
1/2" (12MM) x 180 YD (165M) RED, DK BLUE & DK GREEN				
1/2"	(12mm) 72			
5/8" (15MM) x 180 YD (165M) RED ONLY				
5/8"	(15mm) 60			

# Prescription/Label Protection Tapes...

## LP-16AW... Clear 1.6 mil

1.6 mil (0.041mm). 23 micron Polypropylene Film. **Water Based Acrylic Adhesive.** Prescription, label protection & lamination. High clarity. Adhesion: 19 oz/in. Tensile: 15 lbs/in. Elongation: 140%. Temp. Range: 32°F to 140°F. 3" TalonTape core/carton.

Alternative to 3M #3765; Permacel P-917; American #15T; IPG #261LPT; Central #470, R-2 #150; STA #1201; Shurtape #AP015; Achem #LP16A.

## OPP-20AW... Clear 2.0 mil

**Water Based Acrylic Adhesive.** See page 20 for specifications.

## LP-20CC... Crystal Clear 2.0 mil

2 mil (0.05mm). 28 micron Polypropylene Film. **Solvent Based Acrylic Adhesive.** Prescription, label protection & lamination. Non-yellowing & UV resistant. Adhesion: 23 oz/in. Tensile: 20 lbs/in. Elongation: 140%. Temperature Range: 32°F to 140°F. Crystal clear to the core. See-through "**CRYSTAL CLEAR**" imprinted in two (2) colors on 3" core. Neutral carton.

\* Lower proportional price, as stocked pre-slit.

Alternative to Shurtape #PP-807; Scapa #1250; 3M #821; Achem #12U; Permacel #J/LAR-910.

WIDTH	RLS/CS	CASES		
		1-12	13-39	40+
72 YD (66M)				
4"	(100mm) 18			
5"	(125mm) 12			
5.25"	(133mm) 12			
6"	(150mm) 12			
144 YD (132M)				
4"	(100mm) 18			

144 YD (132M)				
6"	(150mm) 12			

WIDTH	RLS/CS	CASES		
		1-2	3-11	12+
72 YD (66M)				
1/4"	(6mm) 288			
3/8"	(9mm) 216			
1/2"	(12mm) 144			
3/4"	* (19mm) 96			
1"	* (25mm) 72			
1.5"	* (38mm) 48			
1.75"	* (44mm) 42			
2"	* (50mm) 36			
3"	(75mm) 24			
4"	* (100mm) 18			
5"	(125mm) 12			
6"	* (150mm) 12			
49"	(1260mm) LOG		generic core	
49"	(1260mm) 54		crate	

# Cellophane Stationery/Carton Sealing Tape...

## CELLO... Static Free

1.8 mil (0.046mm). Pure cellulose film with a solvent based natural rubber adhesive. Transparent, hand-tearable, eco-friendly tape. Used for sealing, attaching & mending where **biodegradable** tape is required. This **STATIC-FREE** product is highly recommended for the electronics industry. Adhesion: 30 oz/in. Tack: 18#. Tensile: 20 lbs/in. Elongation: >15%. Temperature Range: 32°F to 150°F. 3" neutral paper core.

WIDTH	RLS/CS	CASES		
		1-2	3-11	12+
72 YD (66M)				
1/2"	(12mm) 144			
3/4"	(18mm) 96			
1"	(24mm) 72			
2"	(48mm) 36			
1000 YD (914M)				
6"	(144mm) 2			

Alternative to Shurtape #CT109; Tesa #4101 PV2; 3M #610 & #5912; Clipper #4206; Scapa #1109; IPG #MC-1; Cantech #206.

# Office Supply Tapes...

## SPP-20HTW-1... Clear Stationery Tape

Stationery tape, polypropylene, 2.0 mil (0.05mm). **Hand-tearable.** Water based acrylic adhesive. Adhesion: 22 oz/in. Tensile: 18 lbs/in. Sub-packed. 1" plastic core.

## SPP-20HTW... Clear Stationery Tape

Stationery tape, polypropylene, 2.0 mil (0.05mm). **Hand-tearable (score slit).** Water based acrylic adhesive. Adhesion: 22 oz/in. Tensile: 18 lbs/in. Temperature Resistance: 176°F. Elongation: 120%. Rolls shrink wrapped in a sleeve and sub-packed. 3" neutral core.

## SPP-20RW-B... Clear Stationery Tape

Stationery tape, polypropylene, 2.0 mil (0.05mm). **Razor slit (Not hand tearable).** Best for use in dispensers. Water based acrylic adhesive. Adhesion: 22 oz/in. Tensile: 18 lbs/in. Temperature Resistance: 176°F. Elongation: 120%. Each roll cello-wrapped, no sub-packs (pillow packed). 3" neutral core.

## 20HT-D... Stationery Tape on Half Dispenser

Retail put-up. 1/2" & 3/4" wide x 800" long OPP stationery tape on a half-sided dispenser. Carded (generic imprint). Water based acrylic adhesive. 6 inner cartons per box. Plastic blade.



1/2" (12mm) x 800", carded on a 1/2 dispenser, 6 subpacks of 24 = 144 @ /set = /case  
 3/4" (18mm) x 800", carded on a 1/2 dispenser, 6 subpacks of 16 = 96 @ /set = /case

## INV-20M-1... Invisible Mending Tape

Write-on invisible mending tape, 2.0 mil (25 micron film). **Translucent, frosty-white.** Specially treated matte finish polypropylene film with a solvent based acrylic adhesive. **Hand-tearable, non-glare.** Adhesion: 19 oz/in. Tensile: 20 lbs/in. Elongation: 140%. 1" plastic core.

## INV-20M... Invisible Mending Tape

Prescription/label protection & overlamination, 2.0 mil (0.05mm) total. **Translucent, Frosty-white.** Specially treated matte finish polypropylene film with solvent based acrylic adhesive. Write-on, NON-GLARE for bar code applications, suitable for electronic scanning. Adhesion: 19 oz/in. Tensile: 20 lbs/in. Elongation: 140%. 3" neutral paper core.

49" (1260mm) x 3000M Jumbos Available.

Alternative to 3M #810; STA #1214; Achem #32G, #LM23 & #MT23; Cantech #280-00.

# Hook & Loop...

The Velcro® Texacro® Brand pressure sensitive Hook-n-Loop nylon fastener closure system is manufactured with woven nylon yarns and bound by an acrylic binder coating. Can be sewn to fabrics or applied to rigid surfaces using the factory applied rubber based adhesive. Can be straight-cut or mated and cut. Shear: 13 lbs./in.; Peel: 20 oz./in.; Tensile: 60 lbs./in.



WIDTH	RLS/CS	CASES		
		1-12	13-47	48+
36 YD (1296") 33M				
1/2"	(12mm)	288		
3/4"	(18mm)	192		

Sub-packs: 1/2"=12 rolls; 3/4"=8 rolls  
 Alternative to 3M #600; STA #1202; Cantech #208-00.

WIDTH	RLS/CS	CASES		
		1-12	13-47	48+
72 YD (2592") 66M				
1/2"	(12mm)	144		
3/4"	(18mm)	96		
1"	(24mm)	72		

Sub-packs: 1/2" = 12 rolls; 3/4" = 8 rolls; 1" = 6 rolls  
 Alternative to 3M #600; STA #1202; IPG #15T-12; Cantech #208-00.

WIDTH	RLS/CS	CASES		
		1-12	13-47	48+
72 YD (2592") 66M				
1/2"	(12mm)	144		
3/4"	(18mm)	96		
1"	(24mm)	72		
1.5"	(36mm)	48		

WIDTH	RLS/CS	CASES		
		1-12	13-47	48+
36 YD (1296") 33M				
1/2"	(12mm)	288		
3/4"	(18mm)	192		

Sub-packs: 1/2"=12 rolls; 3/4"=8 rolls  
 Alternative to 3M #810; STA #1204; Cantech #280-00; Achem #32G.

WIDTH	RLS/CS	CASES		
		1-12	13-47	48+
72 YD (2592") 66M				
3/8"	(9mm)	192		
1/2"	(12mm)	144		
3/4"	(18mm)	96		
1"	(24mm)	72		
1.5"	(38mm)	48		
2"	(50mm)	36		
3"	(75mm)	24		
49"	(1260mm)	LOG		neutral core
49"	(1260mm)	54		crate

WIDTH	MODEL #	# OF ROLLS		
		1-9	10-19	20+

25 YD (75 FT) STRIPS	
3/4"	Hook 70
3/4"	Loop 71
1"	Hook 70
1"	Loop 71
2"	Hook 70
2"	Loop 71

Specify black or white when ordering.

* 3/4" DIA. COINS (DOTS) 1028/ROLL	
3/4"	Hook 1753
3/4"	Loop 1753

\*Coins (dots) are stocked in black only. White dots are available with a minimum of 20 rolls (4-week lead time).

Other widths & colors available upon request as a special order.

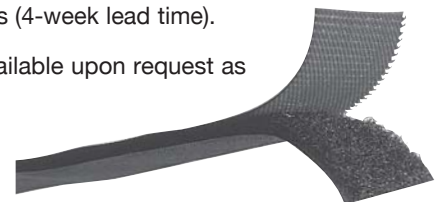

# Tensilized Polypropylene Strapping Tapes...

## PP-500... Tensilized Polypropylene

2.8 mil (0.072mm). **97# Tensile**. Synthetic Rubber/Resin Adhesive. Good initial tack and high shear resistance. Properly applied tape shrinks around loads and holds them tight. Impact strength allows give and take without snapping. Used for palletizing & unitizing corrugated and paperboard boxes. Adhesion to Steel: 55 oz/in. Elongation: 35%. 3" core.

**4 COLORS AVAILABLE: Black, white, rust & clear.**

830mm x 2300M Jumbos Available (black, white & rust).  
1360mm x 2000M Jumbos Available (clear only).

WIDTH	RLS/CS	CASES		
		1-9	10-24	25+
<b>60 YD (55M) 180 FT</b>				
3/8"	(9mm)	192		
1/2"	(12mm)	144		
3/4"	(18mm)	96		
1"	(24mm)	72		
1.5"	(36mm)	48		
2"	(48mm)	36		
3"	(72mm)	24		
32.6"	(830mm)	LOG	BLACK, WHITE & RUST	
53.5"	(1360mm)	LOG	CLEAR ONLY	

Alternative to Tesa #4090, #4091, #4224 & #4287; STA #1222 & #RZ-105; IPG #197 & #805; Shurtape #PS-748.

## PP-800... Heavy-Duty Tensilized Polypropylene

3.8 mil (0.097mm). **149# Tensile**. Synthetic Rubber Based Adhesive. Good initial tack and high shear resistance. Properly applied tape shrinks around loads and holds them tight. Impact strength allows give and take without snapping. The black backing has excellent UV resistance needed for outdoor use. Economical alternative to filament tape for palletizing, bundling, and unitizing corrugated and paperboard boxes. Adhesion to Steel: 55 oz/in. Elongation: 35%. 3" core.

**3 COLORS AVAILABLE: Black, white & clear.**

830mm x 2000M Jumbos Available.

<b>60 YD (55M) 180 FT</b>				
3/8"	(9mm)	192		
1/2"	(12mm)	144		
3/4"	(18mm)	96		
1"	(24mm)	72		
1.5"	(36mm)	48		
2"	(48mm)	36		
3"	(72mm)	24		
32.6"	(830mm)	LOG		

Alternative to Tesa #4288 & #4092 (NOPI); Taratape #200; Shurtape #PS-750; IPG #810.

360 YD (330M) for "L" Clipping available @ proportional cost.

## PP-4298... Appliance Tape (non-staining & residue free)

4.5 mil (0.114mm). **149# Tensile**. Natural Rubber Based Adhesive. **Specially designed to be stain and adhesive transfer resistant.** Features extra high tack, high adhesion and chemical resistance; waterproof and non-toxic. Used for closing, holding, and securing appliances, computers, furniture and office equipment; "L" and "C" clipping. Adhesion to Steel: 32 oz/in. Elongation: 30%. 3" core.

**2 COLORS AVAILABLE: Blue & ivory.**

1250mm x 2000M Jumbos Available.

<b>60 YD (55M) 180 FT</b>				
3/8"	(9mm)	192		
1/2"	(12mm)	144		
3/4"	(18mm)	96		
1"	(24mm)	72		
1.5"	(36mm)	48		
2"	(48mm)	36		
3"	(72mm)	24		
49.2"	(1250mm)	LOG		

Alternative to Tesa #4298; American #497; IPG #815.

## PP-5101... "High Tensile" Polypropylene Tapes

5.0 mil (0.127mm). **228# Tensile**. Synthetic Rubber Based Adhesive. Alternative to filament tape for palletizing, bundling, and reinforcement of various cardboard handles (e.g. flat and top hole handles). Low elongation increases holding power, offering maximum strength for keeping loads intact. Can be easily converted or die-cut. Great for reinforcement of shipping cartons as well as bundling and strapping of heavy goods and securing pallets, which are exposed to shocks during transport. Excellent flexibility. Gray metal-like coloring emphasizes product durability. Adhesion to Steel: 64 oz/in. Elongation: 20%. 3" core.

**1 COLOR AVAILABLE: Metal Gray.**

<b>60 YD (55M) 180 FT</b>				
3/8"	(9mm)	192		
1/2"	(12mm)	144		
3/4"	(18mm)	96		
1"	(24mm)	72		
1.5"	(36mm)	48		
2"	(48mm)	36		
3"	(72mm)	24		
59"	(1500mm)	LOG		

### 360 YD (330M) FOR "L" AND "C" CLIPPING

3/4"	(18mm)	16		
1"	(24mm)	12		
2"	(48mm)	6		
59"	(1500mm)	LOG		

Alternative to Tesa #51010.

See page 65 for STRAPPING TAPE DISPENSERS.

# Filament Reinforced Strapping Tapes...

CASES

WIDTH	RLS/CS	1-11	12-29	30+
-------	--------	------	-------	-----

## FIL-795... Uni-directional Filament

3.9 mil **92# Tensile**. Fiberglass reinforced polypropylene with clear rubber based adhesive. Commodity grade strapping tape. Adhesion: 69 oz/in. Elongation: 4.0%. 3" neutral core.

Alternative to Taratape #199CS; IPG #RG-286; Tesa #53317; 3M #8934, #8959; Cantech #179; Shurtape #GS490; Berry Global #704.

60 YD (55M) 180 FT

3/8"	(9mm)	96
1/2"	(12mm)	72
3/4"	(18mm)	48
1"	(24mm)	36
1.5"	(36mm)	24
2"	(48mm)	24

## FIL-825... Uni-directional Filament

4.3 mil **130# Tensile**. Fiberglass reinforced polypropylene with clear hot melt synthetic rubber adhesive. General purpose filament tape for strapping, bundling and palletizing. Adhesion: 91 oz/in. Elongation: 6%. 3" neutral core.

53.5" (1360mm) x approx. 1500M Jumbos Available.

Alternative to Taratape #190, #193; IPG #RG-3, #RG-303, #RG-788; Tesa #53318; Shurtape #GS500; Sicad #FG10.

60 YD (55M) 180 FT

3/8"	(9mm)	96 or 128	
1/2"	(12mm)	72 or 96	
3/4"	(18mm)	48 or 64	
1"	(24mm)	36 or 48	
1.5"	(36mm)	24 or 32	
2"	(48mm)	24	
3"	(72mm)	16	
4"	(96mm)	12	
12"	(300mm)	4	
53.5"	(1360mm)	LOG	neutral core

## FIL-890... Uni-directional Filament

5.5 mil **200# Tensile**. Fiberglass reinforced polypropylene with clear synthetic rubber based adhesive. Industrial grade filament tape for strapping, bundling and palletizing. Adhesion: 91 oz/in. Elongation: 7%. 3" neutral core.

53.5" (1360mm) x approx. 1500M Jumbos Available.

Alternative to Taratape #197; IPG #750, #RG-315; Cantech #180; 3M #897; Shurtape #GS501; Tesa #53319; Sicad #FG13.

60 YD (55M) 180 FT

3/8"	(9mm)	96 or 128	
1/2"	(12mm)	72 or 96	
3/4"	(18mm)	48 or 64	
1"	(24mm)	36 or 48	
1.5"	(36mm)	24 or 32	
2"	(48mm)	24	
3"	(72mm)	16	
4"	(96mm)	12	
12"	(300mm)	4	
53.5"	(1360mm)	LOG	neutral core

## FIL-930P... Uni-directional Filament

7.5 mil **330# Tensile**. Very high strength polyester backed uni-directional fiberglass filament reinforced tape coated with an aggressive and high shear resistant clear natural rubber resin adhesive. Industrial grade filament tape for strapping, bundling and palletizing. Its high tensile strength and high adhesion to a variety of surfaces make this product suitable for HIGH DEMAND bundling and strength reinforcing applications. Adhesion: 40 oz/in. Elongation: 4.5%. 3" neutral core. MIL spec ASTM D5330, Type II, (replaces PPP-T-97E, Type II).

58.5" (1486mm) x approx. 1550M Jumbos Available.

Alternative to Tesa #53311, IPG #RG16, Cantech #188-00; Shurtape #GS531; Permacel #P-167, #P-247; 3M #880NR, #893, #898.

60 YD (55M) 180 FT

3/8"	(9mm)	96 or 128	
1/2"	(12mm)	72 or 96	
3/4"	(18mm)	48 or 64	
1"	(24mm)	36 or 48	
1.5"	(36mm)	24 or 32	
2"	(48mm)	24	
3"	(72mm)	16	
4"	(96mm)	12	
12"	(300mm)	4	
58.5"	(1486mm)	LOG	neutral core

For "L" Clip long length applications, call for pricing & availability.

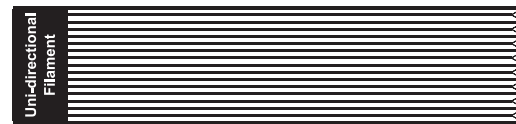

## FIL-835B/D... Bi-directional Filament

4.7 mil. **155# Tensile in both directions**. Fiberglass reinforced polypropylene with clear synthetic rubber adhesive. High strength, bi-directional filament tape for extremely demanding strapping, bundling and palletizing applications. High tear resistance makes it ideal for tabbing/seaming in metal fabricating industry. Adhesion: 91 oz/in. Elongation: 6%. 3" neutral core.

53.5" (1360mm) x approx. 1500M Jumbos Available.

Alternative to 3M #8959; IPG #745; Cantech #190; Sicad #FGBD; Tesa #4579.

60 YD (55M) 180 FT

1/2"	(12mm)	72 or 96	
3/4"	(18mm)	48 or 64	
1"	(24mm)	36 or 48	
1.5"	(36mm)	24 or 32	
2"	(48mm)	24	
3"	(72mm)	16	
4"	(96mm)	12	
6"	(144mm)	8	
7"	(177.8mm)	8	
12"	(300mm)	4	
53.5"	(1360mm)	LOG	neutral core

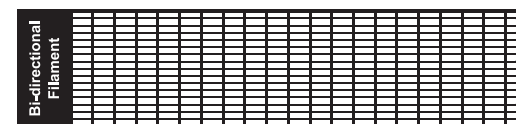

See Filament Tape Dispensers on Page 65.

Most of our items can be custom converted to your needs. Contact us for a quote on custom widths & lengths.

# Printers' Rolls...

## OPP-P ... Acrylic Water Based Adhesive

Surface Printing requires corona treatment. Clear film can be printed on the adhesive side (not recommended if there is high ink coverage due to loss of adhesive tack).

For product details, see pages 20, 21 & 23.

### OPP-26AWP

(38u film) 2.6 mil total CLEAR, TAN & WHITE FILM

6" (144mm)	x	1000yd (914m)	2
6" (150mm)	x	1083yd (990m)	2
12" (288mm)	x	1500yd (1371m)	1

### OPP-32AWP

(48u film) 3.2 mil total CLEAR, TAN & WHITE FILM

6" (144mm)	x	1000yd (914m)	2
12" (288mm)	x	1500yd (1371m)	1

## UPVC-P... Printers' rolls

UPVC with solvent based natural rubber adhesive. Packed 2 rolls per case for 6", and 1 roll per case for 12". 3" neutral core.

Physical Properties...

	32/33 micron	35/37 micron	39 micron	50/60 micron
Adhesion (oz/in)	15	15	15	15
Tensile (lbs/in)	42	42	42	42
Elongation (%)	75	75	90	75
Temperature Range	50°F to 140°F			

Due to the constant fluctuation in pricing, please call for current costs.

WIDTH LENGTH RLS/CS

### OPP-18AWP

(25u film) 1.8 mil total CLEAR, TAN & WHITE FILM

6" (144mm)	x	1000yd (914m)	2
6" (150mm)	x	1000yd (914m)	2
12" (288mm)	x	2000yd (1828m)	1
12" (300mm)	x	2000yd (1828m)	1

### OPP-20AWP

(28u film) 2.0 mil total CLEAR, TAN & WHITE FILM

6" (144mm)	x	1000yd (914m)	2
6" (150mm)	x	1000yd (914m)	2
12" (288mm)	x	2000yd (1828m)	1
12" (300mm)	x	2000yd (1828m)	1

### OPP-20CP

(28u film) 2.0 mil total

PINK, GREEN, BLUE, ORANGE, RED, BLACK & YELLOW

6" (144mm)	x	1000yd (914m)	2
12" (288mm)	x	2000yd (1828m)	1

Size: 6" (144mm & 150mm) & 12" (288mm & 300mm) x 1083 Yd (990m)

2.2 mil (32/35 micron film)	=	White, tan & clear
2.4 mil (35/37 micron film)	=	Yellow, light green, dark green light blue, dark blue, red, orange, black & white/white (white adhesive)
2.5 mil (37/39 micron film)	=	Fluorescent orange
2.8 mil (50 micron film)	=	White & clear x 660M (720 yd)

CALL FOR PRICING

2" & 3" wide rolls available. Master Jumbos Available.

# Stretch Film...

	TYPE	COLOR	GAUGE	WIDTH x LENGTH	RLS/CS
<b>SBW-80</b>	Stretch Banding	Clear	80 Gauge	3" x 1000' 5" x 1000'	18
<b>SBW-120</b>	Stretch Banding	Clear	120 Gauge	3" x 700'	18
<b>SFW-80EH</b>	Hand Wrap w/ Extended Handles	Clear	80 Gauge	20" x 1000'	4
<b>SFW-80</b>	Hand Wrap	Clear	80 Gauge	15" x 1500' 18" x 1500'	4
<b>SFW-100</b>	Hand Wrap	Clear	100 Gauge	15" x 1000' 18" x 1000'	4
<b>SFW-120</b>	Hand Wrap	Clear	120 Gauge	15" x 1000' 18" x 1000'	4
<b>SFW-80B</b>	Pilferage Deterrent Hand Wrap	Opaque Black	80 Gauge	15" x 1500' 18" x 1500'	4
<b>SFW-100B</b>	Pilferage Deterrent Hand Wrap	Opaque Black	100 Gauge	15" x 1000' 18" x 1000'	4
<b>MSW-75</b>	Cast Machine Wrap	Clear	75 Gauge	20" x 5000'	1

Due to the constant fluctuation in pricing, please call for current costs.



See Page 68 for  
Hand Wrap &  
Stretch Film Dispensers

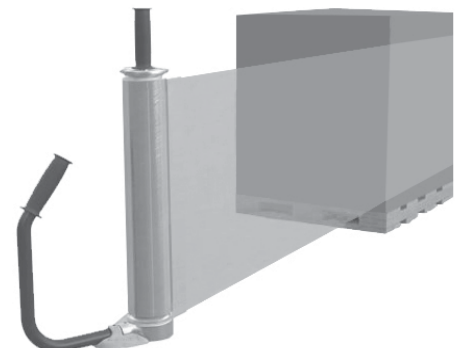

# Magnetic Tapes...

These magnetic tapes are comprised of a **MULTIPOLE ONE FACE FLEXIBLE MAGNET** (composite of strontium and/or barium ferrite particles oriented with a thermoplastic polymer matrix). These permanent magnets remain magnetized indefinitely if not subjected to a demagnetizing force. Magnetic Tape orders are **NON-RETURNABLE** (suggest sampling for approval). Maximum width: 3".

Note...Wider rolls, strips and die cuts are also available. May be **custom** made for your specific applications: Precut or prescored; die-cut into any shape; with or without adhesive; different magnetizing forces and pole arrangements based on product and strength required; in thicknesses from 0.020" to 0.120".



## MAGNETIC TAPES with INDOOR ADHESIVE

3.4 mil double coated polyester tape with an aggressive rubber based pressure sensitive adhesive laminated to the magnet and supplied on a semi-bleached kraft liner. Indoor adhesive was designed for general purpose bonding applications to foams, felts, cloths, primed wood, paper, metal, plastics and most low or un-plasticized substrates. It has an excellent balance of economy versus performance. The polyester carrier provides dimensional stability and superior die cutting properties. Quick Tack: 12.5 lbs/in. Peel Adhesion: 9.5 lbs/in. Application Temperature: Minimum 50°F. Operating Temperature Range: 0°F to 150°F.

### MAG03-I...

1/32" (0.030", 0.762mm) thick with Indoor Adhesive

WIDTH	x	LENGTH	COST PER ROLL
1/2"	x	200 ft	
3/4"	x	200 ft	
1"	x	200 ft	
2"	x	200 ft	
3"	x	200 ft	

### MAG06-I...

1/16" (0.060", 1.524mm) thick with Indoor Adhesive

WIDTH	x	LENGTH	COST PER ROLL
1/2"	x	100 ft	
3/4"	x	100 ft	
1"	x	100 ft	
2"	x	100 ft	
3"	x	100 ft	

## MAGNETIC TAPES with INDOOR/OUTDOOR ADHESIVE

5.2 mil double coated polyester tape with a high performance acrylic based pressure sensitive adhesive laminated to the magnet and supplied on a semi-bleached kraft liner. Indoor/Outdoor Adhesive is for bonding applications where outstanding adhesion, high shear and good solvent resistance are required. The acrylic adhesive offers good clarity and has excellent resistance to UV light exposure. The polyester carrier provides dimensional stability and superior die cutting properties. Quick Tack: 8 lbs/in. Peel Adhesion: 10 lbs/in. Application Temperature: Minimum 40°F. Temperature Range: 0°F to 150°F.

### MAG03-I/O... 1/32" (0.030", 0.762mm) Thick

WIDTH	x	LENGTH	COST PER ROLL
1/2"	x	200 ft	
3/4"	x	200 ft	
1"	x	200 ft	
2"	x	200 ft	
3"	x	200 ft	

### MAG06-I/O... 1/16" (0.060", 1.524mm) Thick

WIDTH	x	LENGTH	COST PER ROLL
1/2"	x	100 ft	
3/4"	x	100 ft	
1"	x	100 ft	
2"	x	100 ft	
3"	x	100 ft	

## MAGNETIC TAPES with WRITEABLE WHITE SURFACE

30 mil magnet with a writeable white vinyl surface (no adhesive). Applications: Automobile Signs, Marketing Displays / Premiums, Business Cards, Warehouse / Barcode Labels, Store / Retail Shelf Labels, Schedule/Planning Boards, and Control Charts.

### MAG03-WO... 1/32" Thick, Write-on Surface

Porous, screen-printable matte white vinyl surface. Writeable with a permanent marker or a water-soluble marker (wipe off with a damp cloth) for non-permanent applications. Note: Wiping off will gray surface over time.

WIDTH	x	LENGTH	COST PER ROLL
1/2"	x	100 ft	
3/4"	x	100 ft	
1"	x	100 ft	
2"	x	100 ft	
3"	x	100 ft	

### MAG03-WOE... 1/32" Thick, Write-on/Wipe-off

Non-porous, smooth, shiny white vinyl surface. Writeable with a dry erase marker and just wipe off.

WIDTH	x	LENGTH	COST PER ROLL
1/2"	x	100 ft	
3/4"	x	100 ft	
1"	x	100 ft	
2"	x	100 ft	
3"	x	100 ft	

# Solid Reflective Tapes...

## REF-5... Engineering Grade (5-year Warranty)

4.5 mil (0.113mm) Polyester reflective tape with acrylic adhesive, wound on a 5.0 mil Polycoated Kraft paper liner. Consists of highly reflective powder (glass beads) that reflects light back to the source. Primarily used to ensure safety in work zone areas, advertisements and traffic signage. Product is hand-tearable, may be screen-printed and die-cut. 3" neutral paper core.

**6 SOLID COLORS AVAILABLE: Silver (white), black, yellow, red, green & blue.**

### CLOSEOUT

#### Physical Properties...

Peel Adhesion: 60 oz/in  
 Tensile Strength: 26 lbs/in  
 Application Temperature: 65°F (18°C)  
 Temperature Resistance: -4°F to 140°F (-20°C to 60°C)

\* MINIMUM 3 INCHES PER ITEM/COLOR.

WIDTH	RLS/CS	* ROLL	CASE
<b>10 YD (30 FT)</b>			
3/8"	(9.5mm)	128	
1/2"	(12.5mm)	96	
3/4"	(19mm)	64	
1"	(25mm)	48	
1.5"	(38mm)	32	
2"	(50mm)	24	
3"	(75mm)	16	
4"	(100mm)	12	
6"	(150mm)	8	
48"	(1200mm)	LOG	

<b>50 YD (150 FT)</b>			
1/2"	(12.5mm)	96	
3/4"	(19mm)	64	
1"	(25mm)	48	
1.5"	(38mm)	32	
2"	(50mm)	24	
3"	(75mm)	16	
4"	(100mm)	12	
6"	(150mm)	8	
48"	(1200mm)	LOG	

## REF-7... Engineering Grade (7-year Warranty)

6.0 mil (0.15mm). Enclosed lens retroreflective urethane film coated with a permanent acrylic adhesive. 6.8 mil white polyethylene coated paper release liner. Primarily designed for permanent & temporary traffic signage. Also used for work zone devices and non-critical signs where retroreflection is necessary. Exceeds requirements of ASTM D4956 Type 1 and EN-12899 RA1. Uniform daytime and nighttime visual appearance. Application surface should be flat (not recommended for unpainted stainless steel surface). Product may be screen printed, thermal transfer printed, thermal die-cut, flat bed sign-cut, drum roller sign-cut, or steel rule sign-cut. 3" neutral paper core.

**6 SOLID COLORS AVAILABLE: Silver (white), yellow, red, orange, green & blue.**

#### Physical Properties...

Peel Adhesion: 43 oz/in  
 Application Temperature: 65°F (18°C)  
 Temperature Resistance: -10°F to 150°F (-23°C to 65°C)

\* MINIMUM 3 INCHES PER ITEM/COLOR.

WIDTH	RLS/CS	* ROLL	CASE
<b>10 YD (30 FT)</b>			
3/8"	(9.5mm)	192	
1/2"	(12.5mm)	144	
3/4"	(19mm)	96	
1"	(25mm)	72	
1.5"	(38mm)	48	
2"	(50mm)	36	
3"	(75mm)	24	
4"	(100mm)	18	
6"	(150mm)	12	
48"	(1200mm)	LOG	

<b>50 YD (150 FT)</b>			
1/2"	(12.5mm)	72	
3/4"	(19mm)	48	
1"	(25mm)	24	
1.5"	(38mm)	24	
2"	(50mm)	12	
3"	(75mm)	12	
4"	(100mm)	8	
6"	(150mm)	6	
48"	(1200mm)	LOG	

<b>250 YD (750 FT)</b>			
48"	(1200mm)	LOG	

Alternative to Avery T-1500 Series, Nippon/Carbide 8100 Series, 3M 3200 Series.

# Striped Reflective Tapes...

## REF-3S... Commercial Grade (3-year Warranty)

3.7 mil (0.095mm) Polyester/vinyl striped reflective tape with acrylic adhesive, wound on a 5.0 mil Polycoated yellow Kraft release liner. 3" neutral paper core.

**4 COLORS: Red/white, red/orange, blue/white & green/white diagonal stripes.**

### CLOSEOUT

#### Physical Properties...

Peel Adhesion: 50 oz/in  
 Tensile Strength: 10 lbs/in  
 Application Temperature: Above 41°F  
 Temperature Resistance: 14°F to 176°F

\* MINIMUM 3 INCHES PER ITEM/COLOR.

WIDTH	RLS/CS	* ROLL	CASE
<b>10 YD (30 FT)</b>			
1"	(25mm)	48	
1.5"	(38mm)	32	
2"	(50mm)	24	
3"	(75mm)	16	
4"	(100mm)	12	
6"	(150mm)	8	
48"	(1219mm)	LOG	

<b>50 YD (150 FT)</b>			
1"	(25mm)	48	
1.5"	(38mm)	32	
2"	(50mm)	24	
3"	(75mm)	16	
4"	(100mm)	12	
6"	(150mm)	8	
48"	(1219mm)	LOG	



# Striped Reflective Tapes...

## REF-5S... Engineering Grade (5-year Warranty)

(formerly REF-S)  
6.8 mil (0.175mm) Polyester/vinyl striped reflective tape with acrylic adhesive, wound on a 6.8 mil Polycoated white Kraft release liner. Meets Federal specifications LS-300C (Reflectivity 1, Class 1) and FP-85 (Type II). 3" neutral paper core.

**2 COLORS: Black/yellow & red/white diagonal stripes.**

### Physical Properties...

Service Life	5-7 years
180° Peel Adhesion:	70 oz/in
Tensile Strength:	11 lbs/in
Application Temperature:	Above 32°F
Temperature Resistance:	-70°F to 160°F
72 hrs @ -70°F:	No effect
72 hrs @ 160°F:	Max 0.012" shrinkage from edge

WIDTH	RLS/CS	* ROLL	CASE
50 YD (150 FT)			
3/4"	(19mm)	48	
1"	(25mm)	36	
1.5"	(38mm)	24	
2"	(50mm)	18	
3"	(75mm)	12	
4"	(100mm)	12	
6"	(150mm)	8	
30"	(762mm)	LOG	

\* MINIMUM 3 INCHES PER COLOR.

Note: Black/yellow diagonal stripes are recommended for long term outdoor use (more resistant to fading).

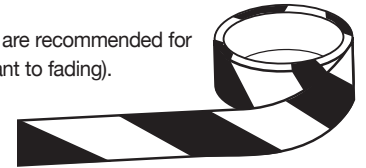

# Oralite® (Reflexite®) Retroreflective Tape...

## REF-DOT...

Oralite® (formerly Reflexite®) Conspicuity material is composed of cube corner (microprism) retroreflective elements integrally bonded to a flexible, smooth-surfaced, tough and weather resistant UV stabilized polymeric film. The prism surfaces are coated with a vacuum deposition of aluminum to provide a mirror surface to the prism facets. The resulting tape is not more than 0.008" thick and comes with an aggressive high-tack pressure-sensitive adhesive.

### Applications...

Oralite® Visibly Better™ Retroreflective conspicuity material is a tough weather and solvent resistant product designed for rugged outdoor use on the sides and rear of trucks, trailers, automobiles, and emergency vehicles to enhance safety on the roadway by improving their visibility. NOTE: NHTSA conspicuity regulations (effective 12/1/93) mandate that all new trailers - 10,000 lbs GVW and 80" wide or larger, must be reflectorized with alternating red & white retroreflective sheeting on the sides, bottom of rear door, and ICC bar; and two pieces of white sheeting on the upper corners of the rear. Application Temperature: minimum 50°F.

### Features/Benefits...

- Durability >>> 5-year or 10-year warranty <<< Withstands brushing off of dirt and grime, and high pressure washing. Polyester based film resists cracking & lifting. Will retain reflectivity even after impact against loading dock or abrasion by chains.
- Unique, single-ply construction ensures impact & abrasion resistance and easy application.
- 0.008" thickness resists dirt accumulation typical of competitor's thicker (0.025"), open-cell construction. Material is extremely thin so there are no raised edges that can catch and tear.
- Unlike competing conspicuity materials, Reflexite® conspicuity material features 100% adhesion, with no grid lines that can fill with water and cause premature adhesive failure.
- Super-high brightness & wide angularity: 10-year pattern. Typically 1000 candlepower with tremendous long sight distance performance; reflects at all applicable angles on the roadway.

### Specification Compliance...

ASTM D4956	NHTSA 49 CFR, Part 571
ASTM D523	DOT-C2 (applicable to 2" only)
ASTM E810	FMVSS 108
LS300C	
FP92	

### When ordering REF-DOT Conspicuity Tapes SPECIFY:

- Durability: 5-year OR 10-year warranty (see pricing below)
- Red/White Color Pattern: 6"/6" OR 11" (red)/7" (white)
- Type: Solid OR Kiss-Cut roll

\* Note: 10-year 6"/6" pattern is not available in kiss-cut (only solid rolls).

50YD (150 FT)		5-YEAR		10-YEAR	
WIDTH	RLS/CS	ROLL	CASE	ROLL	CASE
1"	(25mm)	36			
1.5"	(38mm)	24			
2"	(50mm)	18			
3"	(75mm)	12			
4"	(100mm)	12			
6"	(150mm)	8			
30"	(762mm)	LOG			

REF-5DOT  
5-Year Pattern



REF-10DOT  
10-Year Pattern



# Oralite® Conspicuity Daybright® Tape...

## REF-5DB... Solid Colors (5-year Warranty)

Oralite® (formerly Reflexite®) Daybright® is a high brightness, weather resistant reflective material. It is designed to provide superior visibility and conspicuity to oncoming motorists which results in improved safety and image.

Daybright® features include Oralite's proprietary microprism technology, long distance sight detection, and thin, flexible construction which is easy to apply. The material has an aggressive high-tack pressure sensitive adhesive. The material is flexible and strong once applied; excellent impact, shrink, and solvent resistance.

**6 COLORS: White, green, red, blue, orange & gold.**

WIDTH	RLS/CS	* ROLL	CASE
50 YD (150 FT)			
1/2"	(12.5mm)	72	
3/4"	(19.0mm)	48	
1"	* (25mm)	<b>36</b>	
1.5"	(38mm)	24	
2"	* (50mm)	<b>18</b>	
3"	(75mm)	12	
4"	(100mm)	12	
6"	(150mm)	8	
30"	(762mm)	LOG	

\*Lower proportional cost, as stocked pre-slit.

5-Year Pattern



## REF-10DB... Solid Colors (10-year Warranty)



10-Year Pattern

**COLORS: Gold and blue.**

**CLOSEOUT**

WIDTH	ROLL
50 YD (150 FT)	
2"	(50mm)

**Note:**

Available in additional colors and widths for special orders. Please call for pricing and minimums.

# Oralite® Fluorescent Reflective Tape...

## REF-DBF... Solid Fluorescent Colors (5-year Warranty)

Oralite® (formerly Reflexite®) Fluorescent Conformable Graphic Sheeting is a tough weather and solvent resistant product designed for rugged outdoor use. The product is die cuttable, plotter cuttable, easy to apply to smooth painted or unpainted vehicle surfaces, and highly conformable to shapes and curves. Used for increased visibility on vehicles.

Composed of cube corner (microprism) retroreflective elements integrally bonded to a flexible, smooth-surfaced, tough weather resistant, UV stabilized polymeric film. The prism surfaces are coated with a vacuum deposition of aluminum to provide a mirror surface to the prism facets. The material is flexible and strong once applied; excellent impact, shrink, and solvent resistance. Specially formulated to adhere to a variety of surfaces including: painted steel, clear coat lacquer, and aluminum. The adhesive is protected by a release liner that shall be removed by peeling, without soaking in water or solvents.

**2 COLORS: Fluorescent lime-yellow & fluorescent orange.**

WIDTH	RLS/CS	ROLL	CASE
50 YD (150 FT)			
1"	(25mm)	20	
2"	(50mm)	10	
30"	(762mm)	LOG	

**Note:**

Available in additional colors and widths for special orders. Please call for pricing and minimums.

5-Year Pattern



# Photoluminescent Tapes...

**PGD-6... Safety Grade (6 Hours)**

**PGD-10... High Energy (10 Hours)**

**PGD-24... Ultra Premium (24 Hours)**



**PGD-24HDP... Printable Premium (24 Hours)**

A flexible polyester laminated photoluminescent film coated with a permanent acrylic adhesive and backed with a polycoated paper release liner. The photoluminescent pigments absorb and store energy from normal, ambient light. In sudden darkness, the tape is immediately visible. These non-electric safety system tapes easily and inexpensively affix to walls, handrails, stairways, columns, doorframes and baseboards. Tape will glow in total darkness after exposure to artificial or natural light - it is fully charged within 30 minutes. **Glow brightest the first 30 minutes after activation has ceased, but will remain clearly visible in a completely dark room to the night-adapted eye for approx. 6 hours (PGD-6), 10 hours (PGD-10) or 24 hours (PGD-24 and PGD-24HDP).** Can be die-cut and kiss cut using steel rule dies. 3" neutral paper cores.

All of these tapes are **screen printable**, but **PGD-24HDP** has a unique **matte HD print receptive surface** layer that also allows the film to be **printed digitally, screen printed, and thermal transfer printed**. Send your images directly to your printer (laser or ink-jet) via digital files (no screens or print plates needed) and print.

### Applications:

Used for identification of critical equipment controls, light switch covers, exit and directional signage – especially for escape routes and stairways. Tape clearly labels safety equipment and provides a safe, illuminated path through stairwells, halls, rooms, and other potentially hazardous areas. Simple and inexpensive to install: position, peel off backing, and adhere. This safety system requires virtually no maintenance. Used in hotels, hospitals, schools, public facilities, office buildings and manufacturing plants - wherever people need a safe, reliable, high and low-level egress pathway in case of an emergency, such as sudden power outages or the spread of smoke. Product has excellent resistance to UV light and does not show significant degradation when used outdoors. Also used for labels, decals, novelties, sporting goods, trims, special effects, etc.

Physical Properties:	PGD-6	PGD-10	PGD-24	PGD-24HDP
Color	Light Green			
Adhesive Type	Solvent Based Acrylic			
Tape Thickness (+/- 10%)	11 mils (excluding liner)			
Liner Thickness (+/- 10%)	4.5 mils			6.0 mils
Adhesion to SST (24 hr dwell)	60 oz/in			110 oz/in
Min. Application Temp.	50°F			
UV Stability	Excellent			
Glow Properties*	6-8 Hours	10-15 Hours	20-24 Hours	

\*Glow Properties (DIN 67510 Xe Lamp; 1000 Lx/5 min): Timespan necessary for afterglow brightness to diminish to 0.3 mcd/m<sup>2</sup> - 100X human eye perception. Duration may vary (+/-) as several factors (i.e. type/proximity/angle/wattage of light source, conditions of exposure, etc.) may impact glowing lifespan.

**Also available in non-slip/anti-skid glow-in-the-dark tapes (NST-20GL & NST-20GS). See page 14 for details.**

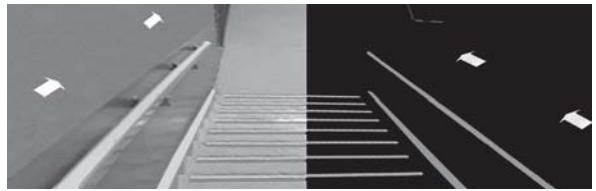

WIDTH                      RLS/CS                      ROLL                      CASE

### PGD-6

10 YD (30 FT)

1/2"	(12.5mm)	144
3/4"	(19mm)	96
1"	(25mm)	72
1.5"	(38mm)	48
2"	(50mm)	36
3"	(75mm)	24
4"	(100mm)	18
6"	(150mm)	12
54"	(1372mm)	LOG

50 YD (150 FT)

1/2"	(12.5mm)	72
3/4"	(19mm)	48
1"	(25mm)	36
1.5"	(38mm)	24
2"	(50mm)	18
3"	(75mm)	16
4"	(100mm)	12
6"	(150mm)	8
54"	(1372mm)	LOG

Alternative to Jessup #7520.

### PGD-10

50 YD (150 FT)

1/2"	(12.5mm)	72
3/4"	(19mm)	48
1"	(25mm)	36
1.5"	(38mm)	24
2"	(50mm)	18
3"	(75mm)	12
4"	(100mm)	8
54"	(1372mm)	LOG

Alternative to Jessup #7530.

**Specify PGD-24 or PGD-24HDP when ordering.**

### PGD-24 & PGD-24HDP

10 YD (30 FT)

1/2"	(12.5mm)	72
3/4"	(19mm)	48
1"	(25mm)	36
1.5"	(38mm)	24
2"	(50mm)	18
3"	(75mm)	12
4"	(100mm)	8
54"	(1372mm)	LOG

50 YD (150 FT)

1/2"	(12.5mm)	72
3/4"	(19mm)	48
1"	(25mm)	36
1.5"	(38mm)	24
2"	(50mm)	18
3"	(75mm)	12
4"	(100mm)	8
54"	(1372mm)	LOG

Alternative to Jessup #7550, #7650.

# Aluminum Foil Tapes (with liner)...



## AF-20A-B... Matte Black, Acrylic Adhesive

**Non-reflective, Matte Black** lacquered 2.0 mil aluminum foil coated with an aggressive acrylic pressure sensitive adhesive; removable white paper release liner. Malleable foil conforms to irregular & curved surfaces. Tape performs well at low and high temperatures (flame retardant). Used to block lighting spills/leakages on heat generating equipment (projectors, light cans, barndoors, etc). Matte black finish does not reflect light. Total Tape Thickness: 3.6 mil. Elongation 3%. Peel Adhesion: 55 oz/in. Temperature Range: -22°F to 302°F. 3" neutral core.

WIDTH	RLS/CS	ROLL	CASE
<b>27 YD (25M) BLACK</b>			
2"	(50mm)	24	

Replaces AF-22A-B.

## AF-12R... Rubber Adhesive

Economical aluminum foil tape for moderate demand applications. 1.2 mil dead soft aluminum foil, coated with an aggressive hot melt synthetic rubber adhesive; removable release liner. Malleable foil conforms well to irregular surfaces. Total Tape Thickness: 2.8 mils. Peel Adhesion: 91 oz/in. Tensile: 10.3 lb/in. Elongation: 3%. Temperature Range: -4°F to 176°F. 3" neutral core.

47.25" (1200mm) x 1200M (1312yd) Jumbos Available.

WIDTH	RLS/CS	CASES		
		1-5	6-11	12+
<b>50 YD (150 FT)</b>				
1/2"	(12mm)	96		
3/4"	(18mm)	64		
1"	(24mm)	48		
1.5"	(36mm)	32		
<b>2"</b>	<b>(48mm)</b>	<b>24</b>		
2.5"	(63mm)	20		
<b>3"</b>	<b>(72mm)</b>	<b>16</b>		
4"	(96mm)	12		
6"	(144mm)	8		
47.25"	(1200mm)	LOG		

Alternative to Nashua #331; Ideal #488E.

## AF-12A... Acrylic Adhesive

Economical aluminum foil tape for moderate demand applications. 1.2 mil dead soft aluminum foil, coated with a solvent based acrylic adhesive; removable paper release liner. Malleable foil conforms well to irregular surfaces. Used for vapor barrier protection, waterproof sealing, heat reflection & dissipation, masking in paint stripping and electroplating. Total Tape Thickness: 2.8 mils. Peel Adhesion: 73 oz/in. Tensile: 10.3 lb/in. Elongation: 3%. Temperature Range: -22°F to 248°F. 3" neutral core.

47.25" (1200mm) x 1200M (1312yd) Jumbos Available.

			CASES		
WIDTH	RLS/CS	CASES			
		1-5	6-11	12+	
<b>50 YD (150 FT)</b>					
1/2"	(12mm)	96			
3/4"	(18mm)	64			
<b>1"</b>	<b>(24mm)</b>	<b>48</b>			
1.5"	(36mm)	32			
<b>2"</b>	<b>(48mm)</b>	<b>24</b>			
2.5"	(63mm)	20			
<b>3"</b>	<b>(72mm)</b>	<b>16</b>			
4"	(96mm)	12			
6"	(144mm)	8			
47.25"	(1200mm)	LOG			

Alternative to Polyken #332

## AF-16R... Rubber Adhesive

1.6 mil dead soft high-grade aluminum foil coated with an aggressive synthetic rubber adhesive; removable paper release liner. The tape is conformable and will perform well at both low and elevated temperature. Used to maintain the integrity of the vapor barrier, waterproof sealing, heat reflection & dissipation. Used in refrigeration industry, metal patching. Total Tape Thickness: 3.2 mil. Peel Adhesion: 91 oz/in. Tensile: 12.6 lbs/in. Elongation: 3%. Temperature Range: -22°F to 176°F. 3" neutral core.

47.25" (1200mm) x 1000M (1094yd) Jumbos Available.

			CASES		
WIDTH	RLS/CS	CASES			
		1-5	6-11	12+	
<b>50 YD (150 FT)</b>					
1/2"	(12mm)	96			
3/4"	(18mm)	64			
1"	(24mm)	48			
1.5"	(36mm)	32			
<b>2"</b>	<b>(48mm)</b>	<b>24</b>			
2.5"	(63mm)	20			
<b>3"</b>	<b>(72mm)</b>	<b>16</b>			
4"	(96mm)	12			
6"	(144mm)	8			
47.25"	(1200mm)	LOG			

Alternative to Ideal #4558

## AF-16A... Acrylic Adhesive

1.6 mil dead soft high-grade aluminum foil coated with an aggressive solvent based acrylic adhesive; removable paper release liner. Malleable foil conforms well to irregular and curved surfaces; and will perform well at both low and high temperatures. Used for vapor barrier protection, waterproof sealing, heat reflection & dissipation, masking in paint stripping and electroplating. Total Tape Thickness: 3.2 mils. Peel Adhesion: 73 oz/in. Tensile: 12.6 lbs/in. Elongation: 3%. Temperature Range: -22°F to 248°F. 3" neutral core.

47.25" (1200mm) x 1000M (1094yd) Jumbos Available.

			CASES		
WIDTH	RLS/CS	CASES			
		1-5	6-11	12+	
<b>50 YD (150 FT)</b>					
1/2"	(12mm)	96			
3/4"	(18mm)	64			
<b>1"</b>	<b>(24mm)</b>	<b>48</b>			
1.5"	(36mm)	32			
<b>2"</b>	<b>(48mm)</b>	<b>24</b>			
2.5"	(63mm)	20			
<b>3"</b>	<b>(72mm)</b>	<b>16</b>			
4"	(96mm)	12			
6"	(144mm)	8			
47.25"	(1200mm)	LOG			

Other roll widths available upon request.

# Aluminum Foil Tapes (with liner)...

## AF-20R... Rubber Adhesive

2 mil dead soft premium grade aluminum foil coated with an extremely aggressive synthetic rubber adhesive that provides a tight positive grab when smoothed down on work surfaces; removable paper liner. Used in fiberglass duct board systems on seams & joints to maintain the integrity of the vapor barrier. Can also be used on FSK systems. Malleable foil conforms well to irregular & curved surfaces. Total Tape Thickness: 3.6 mil. Peel Adhesion: 91 oz/in. Tensile: 17.1 lbs/in. Elongation: 3.5%. Temperature Range: -4°F to 176°F. 3" neutral core.

47.25" (1200mm) x 1000M (1093yd) Jumbos Available.

WIDTH	RLS/CS	CASES		
		1-5	6-11	12+
50 YD (150 FT)				
1/2"	(12mm)	96		
3/4"	(18mm)	64		
<b>1"</b>	<b>(24mm)</b>	<b>48</b>		
1.5"	(36mm)	32		
<b>2"</b>	<b>(48mm)</b>	<b>24</b>		
2.5"	(63mm)	20		
<b>3"</b>	<b>(72mm)</b>	<b>16</b>		
<b>4"</b>	<b>(96mm)</b>	<b>12</b>		
<b>6"</b>	<b>(144mm)</b>	<b>8</b>		
<b>12"</b>	<b>(300mm)</b>	<b>4</b>		
47.25"	(1200mm)	LOG		

Alternative to Ideal #488; Venture #3530; Shurtape #AF973; Fasson #0802; Polyken #337; Nashua #332; Tesa #53900.

## AF-20A... Acrylic Adhesive

2 mil dead soft high tensile aluminum foil coated with an aggressive solvent based acrylic adhesive; removable paper liner. Malleable foil conforms well to irregular and curved surfaces; and will perform well at both low and elevated temperatures. Can be applied at low temps. Used for vapor barrier protection, waterproof sealing, heat reflection & dissipation, masking in paint stripping and electroplating. Total Tape Thickness: 3.6 mil. Peel adhesion: 73 oz/in. Tensile: 17.1 lbs/in. Elongation: 3.5%. Temperature Range: -22°F to 248°F. 3" neutral core.

47.25" (1200mm) x 1000M (1093yd) Jumbos Available.

WIDTH	RLS/CS	CASES		
		1-5	6-11	12+
50 YD (150 FT)				
1/2"	(12mm)	96		
3/4"	(18mm)	64		
<b>1"</b>	<b>(24mm)</b>	<b>48</b>		
1.5"	(36mm)	32		
<b>2"</b>	<b>(48mm)</b>	<b>24</b>		
2.5"	(63mm)	20		
<b>3"</b>	<b>(72mm)</b>	<b>16</b>		
<b>4"</b>	<b>(96mm)</b>	<b>12</b>		
6"	(144mm)	8		
47.25"	(1200mm)	LOG		

Alternative to Venture #3520CW; Nashua #330; IPG #AC64; Shurtape #AF100; Electro Tape #510; 3M #33805.

## AF-30A... High performance, Acrylic Adhesive

3 mil high strength dead soft aluminum foil coated with an aggressive solvent based acrylic adhesive easy removable paper liner. Malleable foil conforms well to irregular and curved surfaces. Excellent performance at both low and high temperatures. Can be applied at low temps. Used for waterproof sealing, vapor barrier and air leakage protection, heat reflection/dissipation, masking in paint stripping and electroplating. Excellent for die-cutting. Total Tape Thickness: 5.0 mil. Peel Adhesion: 73 oz/in. Elongation: 5%. Temperature Range: -22°F to 302°F. 3" neutral core.

47.25" (1200mm) x 1000M (1093yd) Jumbos Available.

WIDTH	RLS/CS	CASES		
		1-5	6-11	12+
60 YD (180 FT)				
1/2"	(12mm)	96		
3/4"	(18mm)	64		
1"	(24mm)	48		
1.5"	(36mm)	32		
<b>2"</b>	<b>(48mm)</b>	<b>24</b>		
2.5"	(63mm)	20		
3"	(72mm)	16		
4"	(96mm)	12		
6"	(144mm)	8		
12"	(300mm)	4		
47.25"	(1200mm)	LOG		

Alternative to 3M #427, #3363 & #3367; Permacel #P14; Ideal #489; Scapa #P178; Arclad #S-5795; St. Gobain #A662; Polyken #347.

## AF-50A... High performance, Acrylic Adhesive

5 mil high strength aluminum foil backing, combined with a high performance solvent acrylic adhesive, protected by an easy release silicone release paper. Perfect for joining and sealing Foil-Scrim-Kraft facing laminate fiberglass blanket/duct board joints and seams. May also be used for industrial uses. Total Tape Thickness: 7.0 mil. Peel Adhesion: 72 oz/in. Rolling Tack (11mm ball): <6.0 in. Temperature Range: -40°F to 300°F. 3" neutral core.

47.25" (1200mm) x 1000M (1093yd) Jumbos Available.

WIDTH	RLS/CS	CASES		
		1-5	6-11	12+
60 YD (180 FT)				
1/2"	(12mm)	96		
3/4"	(18mm)	64		
1"	(24mm)	48		
1.5"	(36mm)	32		
<b>2"</b>	<b>(48mm)</b>	<b>24</b>		
2.5"	(63mm)	20		
3"	(72mm)	16		
4"	(96mm)	12		
6"	(144mm)	8		
12"	(300mm)	4		
47.25"	(1200mm)	LOG		

Alternative to 3M #3338; Venture #1516CW.

# Aluminum Foil Tapes (without liner)...

## AF-20SW... Self Wound, Acrylic Adhesive

2.0 mil self wound dead soft malleable aluminum foil coated with acrylic adhesive. Malleable foil conforms well to irregular surfaces. Excellent harness wrap tape. Designed for non-critical applications such as sealing out dust and moisture, masking and duct sealing. Can be used for heat reflection in the appliance industry and as a mask for electroplating. This linerless product saves time and labor in stripping of release liner and produces less waste. Total Thickness: 3.6 mils. Adhesion to Steel: 40 oz/in. Tensile: 26 lbs/in. Elongation: 4%. Temperature Range: -40°F to 302°F. 3" neutral core.

WIDTH	RLS/CS	CASES		
		1-5	6-11	12+
60 YD (180 FT)				
1/2"	(12.7mm)	72		
3/4"	(19.0mm)	48		
1"	(25.4mm)	36		
1.5"	(38.1mm)	24		
2"	(50.8mm)	24		

Alternative to 3M #4380; Lamart #215; Venture #807-2 & #2520CW.

## AF-30SW... Self Wound, Acrylic Adhesive

3 mil high strength self wound dead soft aluminum foil coated with an aggressive acrylic adhesive system to create a superior bond. Designed to stick firmly to its own backing. Malleable foil conforms well to irregular surfaces. **Premier product for masking in paint stripping and electroplating.** Used for waterproofing, vapor barrier and air leakage protection, metal patching and sound dampening, as a sealing system in refrigerated appliances and microwave ovens. High reflectivity assures effective heat, light interference, and electrical insulation shielding. 3 mil foil protects outdoor cable splices. Can be applied at low temperatures. Total Thickness: 4.8 mil. Adhesion to Steel: 40 oz/in. Tensile: 36 lbs/in. Elongation: 5%. Temperature Range: -58°F to 302°F. 3" core.

WIDTH	RLS/CS	CASES		
		1-5	6-11	12+
60 YD (180 FT)				
1/2"	(12.7mm)	72		
3/4"	(19.0mm)	48		
1"	(25.4mm)	36		
1.5"	(38.1mm)	24		
2"	(50.8mm)	24		
3"	(76.2mm)	12		
4"	(101.6mm)	8		

Alternative to 3M #425 & #34383; Permacel #P-14; Lamart #213M; Polyken #345; Shurtape #AF-75; Scapa #T3612; Ideal #489.

# Aluminum Foil/Scrim/Kraft Tape...

## AF-FSK-A... with Acrylic Adhesive

## AF-FSK-R... with Rubber Adhesive

A 4.8 mil 3-way dead soft aluminum foil / fiberglass scrim / paper backing coated with a 2 mil aggressive adhesive and wound with a 3.2 mil removable paper release liner. Malleable foil conforms well to irregular and curved surfaces to maximize adhesive contact and provide quick, positive grab to the insulation surface. Used as a closure system for fiberglass and mineral wool insulation systems that are faced with foil, to seal seams and joints on aluminum faced fiberglass duct board, and to provide a vapor barrier that assures the integrity of the system. 3" neutral core.

Specify AF-FSK-A or AF-FSK-R when ordering.

WIDTH	RLS/CS	CASES		
		1-5	6-11	12+
50 YD (150 FT)				
2"	(48mm)	24		
3"	(72mm)	16		
4"	(96mm)	12		
6"	(144mm)	8		
47.25"	(1200mm)	LOG		

Alternative to Nashua #338FSK

### Physical Properties:

	AF-FSK-A	AF-FSK-R
Adhesive	Solvent Based Acrylic	Synthetic Rubber Resin
Tape Thickness (w/o liner)	6.8 mils	6.8 mils
Adhesion	73 oz/in	91 oz/in
Tensile Strength	27.3 lbs/in	27.3 lbs/in
Rolling Ball Tack	6 in	8 in
Temperature Range	-22°F to 176°F	-4°F to 176°F

47.25"(1200mm) x 730M Jumbos Available.

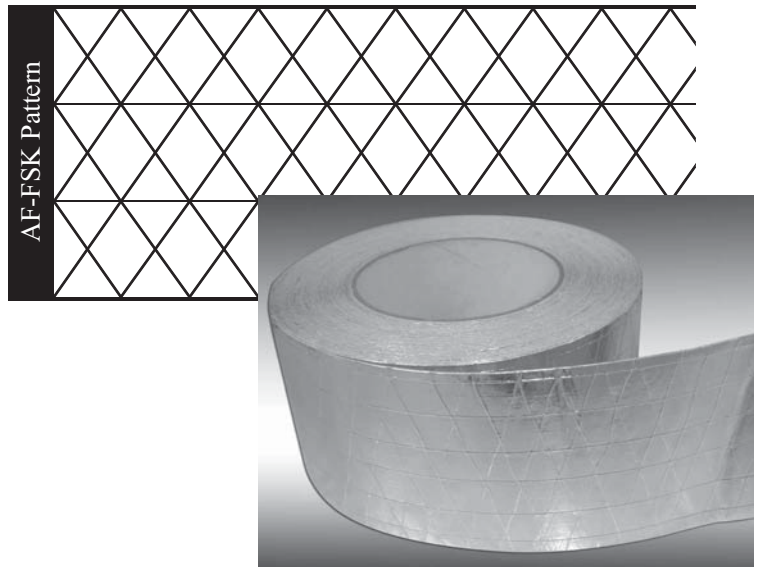

# Copper Foil Tapes...

## CFL-5A... with Acrylic Adhesive

### CFL-5CA... with CONDUCTIVE Acrylic Adhesive

Special electrograde, zero temper, high tensile copper foil tape. Provides excellent solderability. Malleable copper foil conforms well to irregular contours. Its aggressive acrylic adhesive system creates a superior bond. Used for RFI/EMI shielding applications in the electrical/electronics industry. Annealed and non-tarnishing. Meets UL 510 specifications. **CFL-5CA** is coated with an acrylic adhesive which is uniformly dispersed with conductive spheres to provide a very low rate of electrical resistance through the tape. Electrical resistance: 0.003 Ohms/in<sup>2</sup>. 3" plastic core.

#### Typical Applications...

**CFL-5A** - EMI/RFI shielding of small electromagnetic components (i.e. transformer/reactor coils) and cable splices; repairing, modifying & prototype designing wiring boards, supplementary shielding of joints/seams; flat conductor assemblies.

**CFL-5CA** - Cable wrapping to provide EMI/RFI shielding, seaming of EMI/RFI shielded rooms for electrical continuity, static charge draining, surface contact to non-solderable materials (e.g. aluminum or plastics).

#### Physical Properties...

Tape Thickness (w/o liner)	3.2 mil
Foil Thickness	1.4 mil
Peel Adhesion (1 min. Dwell)	37 oz/in
Peel Adhesion (24 hr. Dwell)	59 oz/in
Tensile Strength	37 lbs/in
Elongation	6%
Temperature Range	-40°F to 248°F

# Lead Foil Tapes...

## LF-5A... with Acrylic Adhesive

Highly malleable, pure lead foil with acrylic adhesive. Aggressive, removable acrylic adhesive system is resistant to weather, heat and solvents. Good tack and quick stick. Conforms to irregular and curved surfaces; can be shaped to the most intricate patterns. Meets Fed. Spec HH-T-0029, Amendment 2. Polycoated paper liner. 3" plastic core.

## LF-5R... with Rubber Adhesive

Highly malleable, pure lead foil tape with rubber adhesive. Exhibits excellent adhesion to a wide variety of surfaces, especially to metal, glass, films, foils, and papers. Can be shaped to the most intricate patterns. Can be die-cut into shapes. Complies with Fed. Spec HH-T-29A, Amendment 2. Polycoated paper liner. 3" plastic core.

#### Typical Applications...

**LF-5A...** Masking x-ray plates, electroplating, and chemical milling; radiation barrier, x-ray shielding; sealing double-paned windows; decorative leaded windows.

**LF-5R...** Masking during electroplating; adding weight to golf clubs; weight balancing; electromagnetic & radio frequency shield.

#### Physical Properties...

	LF-5A	LF-5R
Backing	5 mil Lead Foil	5 mil Lead Foil
Adhesive	Acrylic	Rubber
Tape Thickness (w/o liner)	6.0 mil	6.0 mil
Peel Adhesion	35 oz/in	60 oz/in
Tensile Strength	18 lbs/in	18 lbs/in
Temperature Resistance	-30°F to 275°F	40°F to 180°F
Elongation (at break)	15%	15%

WIDTH	RLS/CS	* ROLL	CASE
<b>CFL-5A</b> 36 YD (108 FT)			
1/4"	(6.3mm)	96	
3/8"	(9.5mm)	64	
1/2"	(12.7mm)	48	
3/4"	(19.0mm)	32	
1"	(25.4mm)	24	
1.5"	(38.1mm)	16	
2"	(50.8mm)	12	
3"	(76.2mm)	8	
4"	(101.6mm)	6	
12"	(304.8mm)	2 or 4	
24.8"	(630.0mm)	LOG	

Alternative to 3M #3325; Permacel # P-389; Lamart #881; Chomerics #CCH301; Venture #1650; Saint-Gobain #C661.

\* MINIMUM 6 INCHES.

WIDTH	RLS/CS	* ROLL	CASE
<b>CFL-5CA</b> 36 YD (108 FT)			
1/4"	(6.3mm)	96	
3/8"	(9.5mm)	64	
1/2"	(12.7mm)	48	
3/4"	(19.0mm)	32	
1"	(25.4mm)	24	
1.5"	(38.1mm)	16	
2"	(50.8mm)	12	
3"	(76.2mm)	8	
4"	(101.6mm)	6	
12"	(304.8mm)	2 or 4	
24.8"	(630.0mm)	LOG	

Alternative to 3M #3313; Permacel # P-391; Lamart #882; Chomerics #CCH101; Venture #1697; Saint-Gobain #C665.

\* MINIMUM 6 INCHES.

#### Specify LF-5A or LF-5R when ordering.

WIDTH	RLS/CS	* ROLL	CASE
36 YD (108 FT)			
1/4"	(6.3mm)	36	
3/8"	(9.5mm)	24	
1/2"	(12.7mm)	18	
3/4"	(19.0mm)	12	
1"	(25.4mm)	9	
1.5"	(38.1mm)	6	
2"	(50.8mm)	6	
3"	(76.2mm)	4	
4"	(101.6mm)	2	
20"	(508.0mm)	LOG	

Alternative to 3M #34201, #420; Lamart #245L (acrylic), 245L-R (rubber).

\* MINIMUM 6 INCHES PER ITEM.

# Polyester Splicing & Printed Circuit Board Tapes...

## MYP-25CA (Clear)... Acrylic Adhesive

2.4 mil total. 1 mil polyester film with 1.4 mils of electrical grade acrylic adhesive. Excellent resistance to solvents, heat and chemicals. Used for component packaging & electrical insulation, edge reinforcement on books, webs, etc. Exhibits high resistance to abrasives, acids, oils, aging, staining and water immersion. Meets UL510 Class B (130°C / 266°F). **Adhesion to SST: 35 oz/in.** Tensile Strength: 24 lbs/in. Elongation: 100%. Dielectric Strength: 5.5 kV. Max Temperature: 300°F/30min. 3" plastic core.

Also stocked in 144 yd. length: proportional pricing.

WIDTH	RLS/CS	* ROLL	CASE
72 YD (66M)			
1/4"	(6.3mm)	144 or 192	
3/8"	(9.5mm)	96 or 128	
1/2"	(12.7mm)	72 or 96	
5/8"	(15.9mm)	60	
3/4"	(19.0mm)	48 or 64	
1"	(25.4mm)	36 or 48	
1.5"	(38.1mm)	24 or 32	
2"	(50.8mm)	24	
3"	(76.2mm)	16	
4"	(101.6mm)	12	
43.3"	(1100mm)	LOG	
43.3"	(1100mm)	LOG	x 144 YD

\* MINIMUM 6 INCHES.

Alternative to TLC #CT941; 3M #853, #856; Saint Gobain #M60; Scapa #525; Specialty Tape #S975; Bondtec #371F & #372F.

## MYP-25CS (Clear)... Silicone Adhesive

2.5 mil total. 1 mil polyester film with 1.5 mils of electrical grade silicone adhesive. Designed to be fully stable electrically and mechanically at operating temperatures up to 350°F. Adhesive is cured to provide maximum resistance to chemicals and leaves no residue during masking or holding applications. Excellent resistance to abrasives, acids, oils, aging, staining, and water immersion. Used for splicing silicone coated paper and films. Also used as outer wrap on coils, capacitors, motors, and transformers and for masking in electroplating, anodizing, and PC boards. Meets UL510 Class B (130°C / 266°F). **Adhesion to SST: 27 oz/in.** Tensile Strength: 25 lbs/in. Elongation: 100%. Dielectric Strength: 5.5 kV. Temperature Range: -100°F to 350°F. 3" plastic core.

WIDTH	RLS/CS	* ROLL	CASE
72 YD (66M)			
1/4"	(6.3mm)	144 or 192	
3/8"	(9.5mm)	96 or 128	
1/2"	(12.7mm)	72 or 96	
5/8"	(15.9mm)	60	
3/4"	(19.0mm)	48 or 64	
1"	(25.4mm)	36 or 48	
1.5"	(38.1mm)	24 or 32	
2"	(50.8mm)	24	
3"	(76.2mm)	16	
43.3"	(1100mm)	LOG	

\* MINIMUM 6 INCHES.

Alternative to TLC #CT929; Permacel P-904; Saint Gobain #M52; Bondtec #289; Specialty Tape #S945.

## MYP-3US (Blue)... Silicone Adhesive

3.0 mil total. 1 mil polyester film with 2 mils of silicone adhesive. Resists fumes and chemicals, and leaves minimum residue on removal. Allows visibility of circuitry after masking. Film will not break or split during application or removal. A protective tape, designed to perform well in all phases of masking operations during printed circuit board production. Industry standard plater's tape. Protects surfaces from splashes and chemical fumes in tin/lead stripping and gold tab plating. **Adhesion: 30 oz/in.** Tensile Strength: 25 lbs/in. Elongation: 90%. Max Temp. Resistance: 220°C (428°F)/30 min. 3" plastic core.

WIDTH	RLS/CS	* ROLL	CASE
72 YD (66M)			
1/4"	(6.3mm)	144 or 192	
5/16"	(7.9mm)	120	
3/8"	(9.5mm)	96 or 128	
1/2"	(12.7mm)	72 or 96	
5/8"	(15.9mm)	60	
3/4"	(19.0mm)	48 or 64	
1"	(25.4mm)	36 or 48	
1.5"	(38.1mm)	24 or 32	
2"	(50.8mm)	24	
3"	(76.2mm)	16	
4"	(101.6mm)	12	
50.3"	(1280mm)	LOG	

\* MINIMUM 6 INCHES.

Alternative to Ideal #9190; Scapa #581; Permacel P-377; St. Gobain #M741; 3M #8951.

## MYP-3RS (Red)... Silicone Adhesive

3.0 mil total. 1 mil polyester film with 2 mils of silicone adhesive. Resists fumes and chemicals, and leaves minimum residue on removal. Allows visibility of circuitry after masking. Film will not break or split during application or removal. A protective tape designed to perform well in all phases of masking operations during printed circuit board production. Engineering grade plating tape. Protects surfaces from splashes and chemical fumes in tin/lead stripping and gold tab plating. Suitable for painting. Can be used for splicing of certain silicone coated papers and films. Meets UL510 Class B (130°C / 266°F). **Adhesion: 30 oz/in.** Tensile Strength: 24 lbs/in. Elongation: 100%. Dielectric Strength: 5.5 kV. Temperature Range: -100°F to 350°F. 3" plastic core.

WIDTH	RLS/CS	* ROLL	CASE
72 YD (66M)			
1/4"	(6.3mm)	144 or 192	
5/16"	(7.9mm)	120	
3/8"	(9.5mm)	96 or 128	
1/2"	(12.7mm)	72 or 96	
5/8"	(15.9mm)	60	
3/4"	(19.0mm)	48 or 64	
1"	(25.4mm)	36 or 48	
1.5"	(38.1mm)	24 or 32	
2"	(50.8mm)	24	
3"	(76.2mm)	16	
4"	(101.6mm)	12	
43.3"	(1100mm)	LOG	
43.3"	(1100mm)	LOG	x 144 YD

\* MINIMUM 6 INCHES.

Alternative to Ideal #9111; Scapa #581; Permacel P-377; St. Gobain #M741; 3M #8951; Bondtec #280; Specialty Tape #S945.

Also stocked in 144 yd. length. Proportional pricing.



# Polyester Splicing & Printed Circuit Board Tapes...

## MYP-36GS (Emerald Green)... Silicone Adhesive

3.5 mil total. 2 mil polyester film coated with a 1.5 mil residue-free silicone adhesive. High tack and high adhesion. Tear and break resistant. Its high adhesion and extremely stable adhesive system give it excellent resistance to corrosive chemicals, suitable for photo processing chemistry, acids, oils, solvents, aging, water immersion and staining. One of the cleanest and strongest splicing tapes available. A superior performance leader card splicing tape. Used for splicing siliconized papers, films and non-woven materials in converting. Used for masking adhesive seams in metal bonding processes. Meets UL510 Class B (130°C / 266°F). **Adhesion to SST: 35 oz/in.** Tensile: 44 lbs/in. Elongation: 110%. Dielectric Strength: 6.0 kV. Temperature Range: -100°F to 350°F. Max Short Term: 225°C (437°F)/45 min. 3" plastic core.

WIDTH	RLS/CS	* ROLL	CASE
72 YD (66M)			
1/4"	(6.3mm)	144 or 192	
5/16"	(7.9mm)	120	
3/8"	(9.5mm)	96 or 128	
1/2"	(12.7mm)	72 or 96	
5/8"	(15.9mm)	60	
3/4"	(19.0mm)	48 or 64	
1"	(25.4mm)	36 or 48	
1.5"	(38.1mm)	24 or 32	
2"	(50.8mm)	24	
3"	(76.2mm)	16	
4"	(101.6mm)	12	
38.4"	(975mm)	LOG	

\* MINIMUM 6 INCHES.

Alternative to Ideal #9209, #9211, #9212, #9249; TLC #934; 3M #8902 & #8464; St. Gobain SP-2150, #M830 & #M832; Scapa #572; Berry Global #781; Bondtec #291-7X.

## MYP-36US (Dark Blue)... Silicone Adhesive

3.5 mil total. 2 mil polyester film coated with a 1.5 mil residue-free silicone adhesive. It is one of the cleanest and strongest splicing tapes available with high tack and high adhesion. Good chemical and heat resistance. Bonds well to treated papers, films, foils, etc. Used for splicing siliconized papers, films and non-woven materials in converting. Used for masking adhesive seams in metal bonding processes. Meets UL510 Class B (130°C / 266°F). **Adhesion to SST: 35 oz/in.** Tensile: 44 lbs/in. Elongation: 110%. Dielectric Strength: 6.0 kV. Temperature Range: -100°F to 350°F. 3" plastic core.

WIDTH	RLS/CS	* ROLL	CASE
72 YD (66M)			
1/4"	(6.3mm)	144 or 192	
5/16"	(7.9mm)	120	
3/8"	(9.5mm)	96 or 128	
1/2"	(12.7mm)	72 or 96	
5/8"	(15.9mm)	60	
3/4"	(19.0mm)	48 or 64	
1"	(25.4mm)	36 or 48	
1.5"	(38.1mm)	24 or 32	
2"	(50.8mm)	24	
3"	(76.2mm)	16	
4"	(101.6mm)	12	
38.4"	(975mm)	LOG	

\* MINIMUM 6 INCHES.

Alternative to Ideal #9209, #9211, #9212, #9249; TLC #934; 3M #8902, #8464; St. Gobain #SP-2150, #M830, #M832; Scapa #572; Berry Global #781; Bondtec #293.

## MYP-36OS (Brown/Rust)... Silicone Adhesive

3.8 mil total. 2 mil polyester film coated with a 1.8 mil residue-free silicone adhesive. One of the cleanest and strongest splicing tapes available. Its high adhesion and extremely stable adhesive system give it excellent resistance to photo processing chemicals, acids, oils, solvents, aging, staining and water immersion. Superior performance splicing tape used to bond photographic film to leader card during processing in automated equipment. Excellent masking tape for powder coating applications; used for masking adhesive seams in metal bonding processes. Used for splicing siliconized papers, films and non-woven materials in converting. **Adhesion to SST: 42 oz/in.** Tensile Strength: 44 lbs/in. Elongation: 100%. Dielectric Strength: 6.0 kV. Temperature Range: -100°F to 350°F. Max Short Term: 225°C (437°F)/45 min. 3" plastic core.

WIDTH	RLS/CS	* ROLL	CASE
72 YD (66M)			
1/4"	(6.3mm)	144 or 192	
5/16"	(7.9mm)	120	
3/8"	(9.5mm)	96 or 128	
1/2"	(12.7mm)	72 or 96	
5/8"	(15.9mm)	60	
3/4"	(19.0mm)	48 or 64	
1"	(25.4mm)	36 or 48	
1.5"	(38.1mm)	24 or 32	
2"	(50.8mm)	24	
3"	(76.2mm)	16	
4"	(101.6mm)	12	
38.4"	(975mm)	LOG	

\* MINIMUM 6 INCHES.

Alternative to Ideal #9209, #9211, #9212, #9249; TLC #934; 3M #8902, #8464; St. Gobain #SP-2150, #M830, #M832; Scapa #572; Berry Global #781; Bondtec #291-7X.

## MYP-571PS (Pink)... Silicone Adhesive

2.5 mil total. 1 mil translucent polyester film with 1.5 mils of silicone adhesive. Bonds quickly to silicone coated surfaces. Designed as a more stringent splicing tape for use on all types of substrates. Used in splicing of silicone treated papers, films and other substrates. Used for flexible circuit materials during manufacturing and subsequent processing, and as a protective maskant on panels subject to mild caustic or acid bath etching and plating. **Adhesion to SST: 33 oz/in.** Tensile Strength: 25 lb/in. Elongation: >90%. Max Temp. Resistance: 220°C (428°F)/30 min. 3" plastic core.

WIDTH	RLS/CS	* ROLL	CASE
72 YD (66M)			
1/4"	(6.3mm)	144	
3/8"	(9.5mm)	96	
1/2"	(12.7mm)	72	
5/8"	(15.9mm)	60	
3/4"	(19.0mm)	48	
1"	(25.4mm)	36	
1.5"	(38.1mm)	24	
2"	(50.8mm)	24	
3"	(76.2mm)	16	
50.3"	(1280mm)	LOG	

\* MINIMUM 6 INCHES.

Alternative to Scapa Finite #578; CAP #SC-4055.

# Glass Cloth/Thermal Spray Masking Tape...

## GC-SH7... Glass Cloth/Silicone Adhesive

7.6 mil - Electrical grade glass cloth with silicone adhesive. Conformable; chemical and solvent resistant; printable. Used in strategic masking of areas in thermal spray/plasma spray applications; insulation of electrical apparatus, for sealing and bundling of non-electrical applications where flame retardancy or high heat resistance is required; coil armor wrap. Adhesion: 35 oz/in. Tensile Strength: 140 lbs/in. Elongation: 10%. Dielectric Strength: 3.5 kV. UL510 Insulation Class: 200°C, UL Class H. Temperature Range: -100°F to 500°F. Meets Spec: MIL-I-19166C, Type 7, FAR25853. Color: Natural White. 3" plastic core.

WIDTH	RLS/CS	* ROLL	CASE
36 YD (33M)			
1/2"	(12.7mm)	72 or 96	
3/4"	(19.0mm)	48 or 64	
1"	(25.4mm)	36 or 48	
1.5"	(38.1mm)	24 or 32	
2"	(50.8mm)	18 or 24	
3"	(76.2mm)	12 or 16	
42.3"	(1075mm)	LOG	

Alternative to TLC #907; 3M #69 & #361; T&F #3807; Greenbelt #160-5S; Permacel #P212; IPG #4618 & #RG48; Taconic #6605-07D-NL; Ideal #IT-7300; St. Gobain/Furon #2915-7, #G565 & #G561; Chemfab #340-TS; Lanmar #715-7; Bondtec #832TH; Nitto #185; Scapa #C401; AFC #380-07S; Dewal #469.

## GC-SA7... Aluminum Foil/Glass Cloth/Silicone Adhesive

8.7 mil - Fiberglass cloth with aluminum foil laminate. Provides high strength and reflectivity with excellent flexibility. Cloth is coated with high temperature resistant silicone adhesive. Non-corrosive and flame retardant (withstands open flame/extreme heat). Used in plasma masking, grit blasting, seaming of heat/flame barrier curtains, securing thermal insulation, shielding missile/aircraft components (control cables, harnesses, fuel lines, etc.). Prevents build-up of liquid metal on surfaces that must be protected. Adhesion: 43 oz/in. Tensile Strength: 72 lbs/in. Elongation: 11%. Temperature Range: -94°F to 500°F. Meets Spec: T-MIL 83284, ASTM D1000, ASTM 149, JIS Z0237. Color: Silver. 3" plastic core.

WIDTH	RLS/CS	* ROLL	CASE
36 YD (33M)			
1/2"	(12.7mm)	72 or 96	
3/4"	(19.0mm)	48 or 64	
1"	(25.4mm)	36 or 48	
1.5"	(38.1mm)	24 or 32	
2"	(50.8mm)	18 or 24	
3"	(76.2mm)	12 or 16	
38.25"	(975mm)	LOG	

Alternative to TLC #955; 3M #363 & #3633; Permacel #P-100; Scapa #290; Dewal #407; St. Gobain/Furon #2925-7; Bondtec #P727.

**\* NOTE: For ALL Glass Cloth tapes, MINIMUM 6 inches per item or 5% surcharge will be added to roll price.**

# Skived PTFE Film Tapes...

## TFES-2HD\*, TFES-5, TFES-10... Self-Wound (without liner)

Pure skived PTFE with a high temp. **silicone adhesive**. Used in electrical applications such as harness/coil wraps & separators, transformers & slot liners where good insulation & heat resistance are required. Also used in mechanical applications such as heat sealing bars & jaws, labeling machine pressure pads, chute liners, anti-friction devices, bearings, forming dies, aircraft mold release & guide rails where high temperature, maximum slip and lubricity are required. High elongation permits tight wrapping; conforms to sharp bends/irregular surfaces. \*TFES-2HD is a high density, TENSILIZED skived PTFE film which provides higher tensile strength, lower elongation & higher dielectric strength than regular skived film (primarily used for electrical applications listed above & for roll protection in flat die extrusion). Meets Spec AA-59474 Type-1, Superseding 23594C Type 1. 3" plastic core.

### Physical Properties:

	TFES-2HD	TFES-5	TFES-10
Backing Thickness	2 mil/0.002"	5mil/0.005"	10mil/0.010"
Total Tape Thickness	3.5 mil/0.0035"	7.2 mil/0.0072"	11.5 mil/0.0115"
Break Strength	30 lb/in	15 lb/in	60 lb/in
Adhesion	25 oz/in	30 oz/in	55 oz/in
Elongation	100%	200%	300%
Maximum Operating Temperature	500°F	500°F	500°F
Dielectric Strength	8 kV	12 kV	20 kV
Alternative to:	3M #5480	#5481	
	Permacel #P422	#P421	#P424
	DeWal #204-2HD	#204-5	#204-10
	St. Gobain #2255-2	#2255-5	#2045-10
	Taconic #6445-02	#6115-05	#6115-10
	Chemfab #380-02		
	Lanmar #585-2	#585-5	
	Bondtec #932F		

WIDTH	RLS/CS	LENGTH: 36 YD (108') 33M				18 YD (54') 16.5M	
		TFES-2HD		TFES-5		TFES-10	
		* ROLL	CASE	* ROLL	CASE	* ROLL	CASE
1/4"	(6.3mm)	144					
3/8"	(9.5mm)	96					
1/2"	(12.7mm)	72					
3/4"	(19.0mm)	48					
1"	(25.4mm)	36					
1.5"	(38.1mm)	24					
2"	(50.8mm)	18					
3"	(76.2mm)	12					
21.5"	(546mm)	LOG					
36"	(914mm)	LOG					

**\* NOTE: For all PTFE tapes sold by the roll, MINIMUM 6" per item or 5% surcharge will be added to roll price.**

# Kapton™ Alternative Polyimide Tapes...

## KPT-(Mil)... Wave Solder/Hot Air Leveling Tape

1 and 2 mil Electrical grade Kapton™ alternative POLYIMIDE film coated with a high performance silicone adhesive. Thin and conformable with outstanding tear and abrasion resistance at elevated temperatures. Adhesive will thermoset to increase adhesion values. Leaves minimal residue when removed after manufacturing process; reduces clean-up time and minimizes rejects. Permits observation of board during processing. Excellent resistance to acids, oils, solvents, aging, staining, water immersion. Protects gold contacts from molten solder during hot air wave solder leveling process. Film meets UL510. Formulated to meet spec MIL-P-46112B. 3" plastic core.

### Physical Properties:

	KPT-1	KPT-2
Film Thickness	1 mil	2 mil
Tape Thickness	2.6 mil	3.5 mil
Adhesion	23.8 oz/in	27.4 oz/in
Tensile Strength	>20.6 lbs/in	>36.5 lbs/in
Elongation	>30%	>70%
Dielectric Strength	>4000 V	>8000 V
Temperature Resistance	200°C (392 °F)/30 min	
Film Color	Gold/Amber (transparent)	

™ DuPont Trademark

WIDTH	RLS/CS	* ROLL	CASE
<b>KPT-1 36 YD (33M)</b>			
1/4"	(6.3mm)	144 or 192	
3/8"	(9.5mm)	96 or 128	
1/2"	(12.7mm)	72 or 96	
5/8"	(15.9mm)	60	
3/4"	(19.0mm)	48 or 64	
7/8"	(22.2mm)	48	
1"	(25.4mm)	36 or 48	
1.5"	(38.1mm)	24 or 32	
2"	(50.8mm)	24	
3"	(76.2mm)	12	
4"	(101.6mm)	12	
25.2"	(640mm)	LOG	

Alternative to Dielectric Polymer #NT-590; Permacel #P-221; 3M #5419, #5433; Shurtape #6325-01; Scapa #557; St. Gobain/Furon #2345-1; Dewal #304-1; Ideal #9321, #IT-7170; TLC #CT961; Specialty Tapes #S2210; Lanmar #595-1; Chemfab #360-1S; Tesa #4428.

WIDTH	RLS/CS	* ROLL	CASE
<b>KPT-2 36 YD (33M)</b>			
1/4"	(6.3mm)	144 or 192	
3/8"	(9.5mm)	96 or 128	
1/2"	(12.7mm)	72 or 96	
5/8"	(15.9mm)	60	
3/4"	(19.0mm)	48 or 64	
7/8"	(22.2mm)	48	
1"	(25.4mm)	36 or 48	
1.5"	(38.1mm)	24 or 32	
1.75"	(44.4mm)	24	
2"	(50.8mm)	24	
3"	(76.2mm)	12	
4"	(101.6mm)	12	
19.7"	(500mm)	LOG	

Alternative to Electro Tape #95-2; Ideal #9322; T&F #3903; American #304-2; Anchor #K-350; Permacel #P-222; Taconic #6325-02; Bery Global #2345-2; Tesa #4429; Dewal #303-2.

**\* NOTE: For all KPT Tapes, MINIMUM 6 inches per item.**

# PTFE Coated Glass Fabric Tapes...

## TFE Mil thickness (-3, -5, -6, or -10)... Specify with (WL) or without (SW) liner.

Impregnated fiberglass cloth, consisting of warp and fill yarns, coated with a high temperature **silicone adhesive**. Excellent electrical, mechanical and chemical properties. Used as a primary insulation in a variety of electrical equipment and heat sealing bars, chute liners, gaskets, bearing surfaces, tabletop covers, guide rails and roll covers. Low friction surface; abrasion resistant. Product comes standard with liner ("WL") or available self-wound ("SW"). 1/2" AND 3/4" WIDE ROLLS MUST BE SELF WOUND. Also available without adhesive ("NA"). 3" plastic core.

### Physical Properties

	TFE-3WL or TFE-3SW	TFE-5WL or TFE-5SW	TFE-6WL or TFE-6SW	TFE-10WL or TFE-10SW
Backing Thickness	2.8 mil/0.0028"	4.6 mil/0.0046"	5.4 mil/0.0054"	9.1 mil/0.0091"
Total Tape Thickness	5.0 mil/0.0050"	6.8 mil/0.0068"	8.4 mil/0.0084"	12.1 mil/0.0121"
Breaking Strength (Warp   Fill)	100 lb/in   70 lb/in	135 lb/in   120 lb/in	150 lb/in   140 lb/in	290 lb/in   180 lb/in
Adhesion	43 oz/in	36 oz/in	40 oz/in	60 oz/in
Elongation (Warp   Fill)	3.4%   2.0%	2.9%   3.2%	3.0%   4.0%	4.0%   3.4%
Operating Temperature Range	-100°F to 500°F	-100°F to 500°F	-100°F to 500°F	-100°F to 500°F
Electrical Strength	5.0 kV	6.1 kV	6.5 kV	8.0 kV
Alternative to:	3M #5451	#5452	#5453	#5454
	DeWal #134-3	#134-5	#134-6	#134-10
	St. Gobain #SG25-03	#SG25-05	#SG25-06	#SG25-10
	Greenbelt #100-3S	#100-5S	#100-6S	#100-10S
	W.F. Lake #L40S-3	#L40S-5	#L-40S-6	#L-40S-10
	Taconic #6085-03	#6085-05	#6085-06	#6085-10
	Chemfab #350-35	#350-5S	#350-6S	#350-10S
	Lanmar #635-3	#635-5	#635-6	#635-0
	AFC #25003S	#25005S	#25006S	#25010S

WIDTH	RLS/CS	LENGTH: 36 YD (108') 33M							
		TFE-3WL or TFE-3SW		TFE-5WL or TFE-5SW		TFE-6WL or TFE-6SW		TFE-10WL or TFE-10SW	
		* ROLL	CASE	* ROLL	CASE	* ROLL	CASE	* ROLL	CASE
1/2"	(12.7mm)	72							
3/4"	(19.0mm)	48							
1"	(25.4mm)	36							
1.5"	(38.1mm)	24							
2"	(50.8mm)	18							
3"	(76.2mm)	12							
36"	(914.0mm)	LOG							

PTFE Coated Glass Fabrics Without Adhesive ("NA") (* cost per inch width)	TFE-3NA		TFE-5NA		TFE-6NA		TFE-10NA	
	18 YD	36 YD	18 YD	36 YD	18 YD	36 YD	18 YD	36 YD

**\* NOTE: For all PTFE tapes sold by the roll, MINIMUM 6" per item or 5% surcharge will be added to roll price.**

# UHMW Polyethylene Tapes...

## UHMW-(Mil)... Acrylic Adhesive

Ultra High Molecular Weight (UHMW) Polyethylene Tape. 3 mil, 5 mil, 10 mil, 15 mil and 20 mil with an aggressive acrylic adhesive. Its high chemical and abrasion resistance and extremely low coefficient of friction makes this a versatile engineering material for many severe service applications. Materials slide freely over tape surface with no slip/stick tendency. High impact strength and shock absorbing properties. Outwears Teflon™ and is a good replacement when high temperature resistance is not a requirement. Rub strips on conveyors, bearings and sliding surfaces, chutes and hopper liners, dead plates, wear pads, guide rails, furniture and drawer slides. Used primarily in automotive and mechanical applications. UHMW-3A, 5A, 10A, & 15A meets automotive specs: Chrysler MS-CH612, Ford ESB-M3G123-B, GM 6419M. UHMW-3A, 5A, 10A, & 15A are wound on a 4 mil white paper liner; UHMW-20A is wound on a blue poly liner. 3" plastic core. FILM COLOR: Natural transparent.

Physical Properties...		UHMW-3A	UHMW-5A	UHMW-10A	UHMW-15A	UHMW-20A
Backing Thickness		3.0 mil	5.0 mil	10.0 mil	15.0 mil	20.0 mil
Total Tape Thickness (w/o liner)		5.0 mil	7.0 mil	11.8 mil	17.3 mil	21.8 mil
Peel Adhesion		50 oz/in	60 oz/in	50 oz/in	50 oz/in	60 oz/in
Tensile Strength		18 lb/in	30 lb/in	60 lb/in	60 lb/in	50 lb/in
Elongation		300%	300%	300%	300%	300%
Max. Operating Temperature		300°F	300°F	300°F	300°F	300°F
Alternative to:	Dewal	#423-3	#423-5FW	#423-10	#423-15	#423-20
	3M	#5425, #9325	#5430	#5423		
	Lamart	#150-3	#150-5	#150-10		
	Venture		#967	#968		
	St. Gobain	#2302-3R	#2302-5R	#2300-10R	#2302-15	#2302-20R
	Specialty Tape		#S882	#S884		
	Taconic	#6311-03	#6311-05	#6311-10	#6311-15	#6311-20
	Lanmar	#622-3R	#622-5R	#622-10R		#622-20R

WIDTH	RLS/CS	LENGTH: 36 YD (33M) 108'				LENGTH: 18 YD (16.5M) 54'					
		UHMW-3A		UHMW-5A		UHMW-10A		UHMW-15A		UHMW-20A	
		* ROLL	CASE	* ROLL	CASE	* ROLL	CASE	* ROLL	CASE	* ROLL	CASE
1/2" (12.5mm)	72 or 96										
3/4" (19mm)	48 or 64										
1" (25mm)	36 or 48										
1.5" (38mm)	24 or 32										
2" (50mm)	18 or 24										
3" (75mm)	16										
4" (100mm)	12										
27" (26") (673mm)	LOG										

\* MINIMUM 6 INCHES PER ITEM.

# Metalized Polyester Film Tapes...

## MMYP-1... Acrylic Adhesive

1 mil Metalized Polyester Film with a brilliant, vibrant, mirror-like finish, coated with an aggressive, long lasting acrylic adhesive. Tapes have excellent chemical and thermal stability. Silver can be qualified to meet Federal Specification #L-T-100B, Type II. 3" plastic core.

### Applications...

Reflective shielding; industrial and graphic arts; decorative trim, automotive trim, nameplates, electric appliances, advertising displays; suitable for micro film splicing; also can be used in photo sensing applications to detect splices and to facilitate roll changeovers- recommend test sampling first.

### Physical Properties:

Adhesive	Acrylic
Total Thickness	2.1 mil
Adhesion to Steel	45 oz/in
Tensile Strength	24 lbs/in
Elongation	100%
Temperature	up to 300°F

WIDTH	RLS/CS	LENGTH: 72 YD (66M)			
		SILVER		OTHER COLORS	
		* ROLL	CASE	* ROLL	CASE
1/4" (6.3mm)	192				
3/8" (9.5mm)	128				
1/2" (12.7mm)	96				
3/4" (19.0mm)	64				
1" (25.4mm)	48				
1.5" (38.1mm)	32				
2" (50.8mm)	24				
3" (76.2mm)	16				
4" (101.6mm)	12				
6" (152.4mm)	8				
38.4" (975mm)	LOG				

Alternative to 3M #850; Ideal #505; TLC #CT941M; Achem #MP50; Tesa #4137; Venture #1555CW; St. Gobain/Furon #MT150 & #PS100; Specialty Tapes #S298; Decker #136.

\* MINIMUM 6 INCHES PER COLOR.

**6 COLORS AVAILABLE: SILVER, BLACK, GOLD, GREEN, BLUE & RED.**

(Other colors available as special order)

38.4" (975mm) x 660M (722 yd) Jumbos Available.

# Double Coated PVC Tapes...

## DC-4414W... PVC (White)

5.5 mil exclusive of liner. 1.5 mil White PVC film coated on both sides with a **solvent based acrylic adhesive**. This product comes with a gold siliconized paper release liner. Extremely aggressive adhesive bonds well to nearly all materials, even to difficult surfaces like foams, PE and PP films. Excellent temperature, UV, aging, and water vapor resistance. Used for secure attachment of extruded plastic profiles in furniture and general industries. Used extensively for mounting of signs and large format graphics. Recommended for bonding trims in automotive and other industries. **Adhesion (1 min dwell): 80 oz/in.** Temperature Resistance: -40°F up to 158°F. 3" neutral core/carton.

WIDTH	RLS/CS	CASES		
		1-2	3-11	12+
<b>36 YD (33M)</b>				
3/8"	(9mm)	96		
1/2"	(12mm)	72		
3/4"	(18mm)	48		
1"	(24mm)	36 or 48		
1.5"	(36mm)	24		
2"	(48mm)	18 or 24		
3"	(72mm)	12 or 16		
4"	(96mm)	12		
39.4"	(1000mm)	LOG		

39.4" (1000mm) x 500M (547Yd) Jumbos Available.

## DC-4420... PVC (White)

9.1 mil exclusive of liner. 1.5 mil White PVC film coated on both sides with a **solvent based acrylic adhesive**. Gold siliconized paper liner. Extremely aggressive adhesive bonds well to nearly all materials, even to difficult surfaces like foams, PE and PP films. Excellent temperature, UV, aging, and water vapor resistance.

### Applications...

Used for bonding rubber, plastic, metal and wood substrates; for permanent mounting of nameplates and decorative trim on appliances and furniture.

### Physical Properties...

Adhesion to SST (1 min dwell) 110 oz/in.  
 Elongation 35%  
 Minimum Application Temp: +15°C (59°F)  
 Temperature Resistance -40°F to +158°F continuous

54" (1372mm) x 600M (656yd) Jumbos Available.

Add -PC for plastic cores + \$ per case or log.

<b>36 YD (33M)</b>				
3/8"	(9mm)	96		
1/2"	(12mm)	72		
3/4"	(18mm)	48		
1"	(24mm)	36 or 48		
1.5"	(36mm)	24		
2"	(48mm)	18 or 24		
3"	(72mm)	12 or 16		
4"	(96mm)	12		
54"	(1372mm)	LOG		

<b>60 YD (55M)</b>				
1/2"	(12mm)	72		
3/4"	(18mm)	48		
1"	(24mm)	36		
1.5"	(36mm)	24		
2"	(48mm)	18 or 24		
3"	(72mm)	12 or 16		
54"	(1372mm)	LOG		

Alternative to Tesa #4970; Scapa #S301; #3M #419; IPG #597; Lohman #370.

Other roll widths and/or lengths available upon request.

## DC-4420LB... PVC (Clear or \*Black)

7.87 mil (0.20mm) exclusive of liner. 3.2 mil (80 micron) PVC film coated on both sides with a **water based acrylic adhesive**. Gold siliconized paper liner. Extremely aggressive adhesive bonds well to nearly all materials, even to difficult surfaces like foams, PE and PP films. Excellent temperature, UV, aging, and water vapor resistance.

### Applications...

Used for bonding rubber, plastic, metal and wood substrates; for permanent mounting of nameplates and decorative trim on appliances and furniture.

### Physical Properties...

Adhesion (1 hr. dwell) 157 oz/in.  
 Shear resistance 14 lbs/in<sup>2</sup>  
 Temperature resistance -40°F to +176°F



39.4" (1000mm) x 500M (547 yd) Jumbos Available.

<b>36 YD (33M)</b>				
3/8"	(9mm)	96		
1/2"	(12mm)	72		
3/4"	(18mm)	48		
1"	(24mm)	36 or 48		
1.5"	(36mm)	24		
2"	(48mm)	18 or 24		
3"	(72mm)	12		
4"	(96mm)	12		
39.4"	(1000mm)	LOG		

\* FOR BLACK FILM, ADD 5% (x 1.05).

<b>60 YD (55M)</b>				
3/8"	(9mm)	96		
1/2"	(12mm)	72		
3/4"	(18mm)	48		
1"	(24mm)	36		
1.5"	(36mm)	24		
2"	(48mm)	18 or 24		
3"	(72mm)	12		
39.4"	(1000mm)	LOG		

\* FOR BLACK FILM, ADD 5% (x 1.05).

## DC-4425AR... PVC (White)

9.84 mil exclusive of liner. The 3.2 mil white PVC film is coated on both sides with a modified acrylic adhesive, solvent free, based on aqueous dispersions. Gold release paper liner. Its adhesive strength builds with time and is very moisture and temperature resistant. This adhesive has good tack and adheres extremely well to PE and PP films as well as to rough surfaces such as chipboards. APEO/APE Free. **Adhesion to SST: 164 oz/in** (1 hr dwell). Temperature Resistance: -40°F to 266°F.

<b>36 YD (33M)</b>				
3/8"	(9mm)	96		
1/2"	(12mm)	64		
3/4"	(18mm)	48		
1"	(24mm)	36 or 48		
1.5"	(36mm)	24		
2"	(48mm)	18 or 24		
3"	(72mm)	12 or 16		
4"	(96mm)	12		
39.4"	(1000mm)	LOG		

39.4" (1000mm) x 500M Jumbos Available.

# Double Coated Polyester Tapes...

## DC-1114... Polyester (Clear)

3.5 mil (0.09mm) exclusive of liner. 0.5 mil thin clear polyester film coated on both sides with an aggressive synthetic **hot melt rubber adhesive**, and wound on a 2.7 mil white siliconized paper release liner. Superior moisture resistance in humid conditions once bonded. Excellent quick-stick. Ideal for laminating difficult substrates and various webs, such as foams and foils. Perfect for splicing of papers, plastics, films, foils, etc. Used in general purpose bonding and mounting (e.g. nameplates, mouse pad assembly). **Adhesion to SST: 64 oz/in.** Elongation: 130%. Environmentally friendly; solventless adhesive. Temperature Resistance: -4°F to 140°F. 3" neutral core/carton.

## DC-4106LW... Polyester (Clear)

2.4 mil (0.06mm) exclusive of liner. 0.4 mil clear polyester film coated on both sides with a modified **solvent free water based acrylic adhesive**. Light blue siliconized paper liner. Adheres to nearly all materials, even to difficult surfaces like foams and PE film. Good alternative to adhesive transfer tapes as it is thin, hand tearable, and easier to apply by hand. Very good temperature, UV, aging and water vapor resistance. No plasticizer migration. Can be used for splicing, bonding, and laminating paper, corrugated paper, films, plastics, foils, etc. For mounting nameplates, keyboard assemblies; laminating various webs. **Adhesion: 47 oz/in.** Temperature Resistance: -40°F to 212°F. 3" neutral core/carton.

## DC-4109RS... Polyester (Clear)

3.5 mil (0.09mm) exclusive of liner. 0.5 mil clear polyester film substrate coated on both sides with a modified **solvent free water based acrylic adhesive**. Tape is provided on a gold siliconized paper liner. Superior moisture resistance in high humidity. Excellent low and high temperature performance. Perfect for splicing of various materials such as papers, plastics, films, foils, etc., for mounting nameplates, keyboard assembly, and for laminating dissimilar metals. **Adhesion: 29 oz/in.** Temperature Resistance: -40°F to 392°F. 3" neutral core/carton.

## DC-4109CS... Polyester (Clear)

3.5 mil (0.09mm) exclusive of liner. 0.5 mil clear polyester film substrate coated on both sides with an extremely aggressive quick stick, high peel and high shear strength, **solvent free water-based pure acrylic adhesive**. Wound on a siliconized 2.7 mil, 78 gr. white glassine paper release liner. Superior moisture resistance in high humidity. **Adhesion: 44 oz/in.** Temperature Resistance: -40°F to 248°F. High speed flying splice of paper, corrugated paper, plastics, films, foils, etc.; mounting nameplates, keyboard assembly; laminating dissimilar metals. 3" neutral core/carton.

39.4" (1000mm) x 1000M Jumbos Available.

## DC-4109/R... Polyester (Bright Red)

3.5 mil (0.089mm) exclusive of liner. 0.5 mil **bright red** polyester film (opaque) coated on both sides with an aggressive, **clear acrylic adhesive**. 55# Kraft paper liner. High tack/adhesion/shear strength, excellent temperature performance. For splicing paper, plastics, films, foils, low/high energy surfaces and other continuous web processes when a visual splice is critical. **Adhesion: 95 oz/in.** Tensile: 7.5 lbs/in. Elongation: 100%. Temperature Resistance: -40°F to 225°F (175°F for continuous load). 3" neutral core/carton.

WIDTH	RLS/CS	CASES		
		1-2	3-11	12+
60 YD (55M)				
1/4"	(6mm)	192		
3/8"	(9mm)	128		
1/2"	(12mm)	96		
3/4"	(18mm)	64		
1"	(24mm)	48		
1.5"	(36mm)	32		
2"	(48mm)	24		
3"	(72mm)	16		
4"	(96mm)	12		
6"	(144mm)	8		
54"	(1370mm)	LOG		

Alternative to Adchem #3175M; Venture #512; Scapa #S-662.

54" (1370mm) x approx. 1000M Jumbos Available.

60 YD (55M)				
1/4"	(6mm)	144		
3/8"	(9mm)	96		
1/2"	(12mm)	72 or 96		
3/4"	(18mm)	48 or 64		
1"	(24mm)	36 or 48		
1.5"	(36mm)	24 or 32		
2"	(48mm)	18 or 24		
3"	(72mm)	12 or 16		
4"	(96mm)	12		
39.4"	(1000mm)	LOG		

Alternative to Tesa #4972.

39.4" (1000mm) x 1000M Jumbos Available.

60 YD (55M)				
1/4"	(6mm)	192		
3/8"	(9mm)	128		
1/2"	(12mm)	96		
3/4"	(18mm)	64		
1"	(24mm)	48		
1.5"	(36mm)	32		
2"	(48mm)	24		
3"	(72mm)	16		
4"	(96mm)	12		
59"	(1500mm)	LOG		

59" (1500mm) x 800M Jumbos Available.

60 YD (55M)				
1/4"	(6mm)	144		
3/8"	(9mm)	96		
1/2"	(12mm)	72		
3/4"	(18mm)	48		
1"	(24mm)	36 or 48		
1.5"	(36mm)	24 or 32		
2"	(48mm)	18 or 24		
3"	(72mm)	12 or 16		
4"	(96mm)	12		
6"	(144mm)	8		
39.4"	(1000mm)	LOG		

Alternative to Venture #514CW & #518; 3M #415; Adchem #254M; Int'l Tape #202 & #203; Anchor #593; Berry Global #126.

60 YD (55M)				
1/2"	(12mm)	72 or 96		
3/4"	(18mm)	48 or 64		
1"	(24mm)	36 or 48		
1.5"	(36mm)	24 or 32		
2"	(48mm)	18 or 24		
3"	(72mm)	12 or 16		
56"	(1422mm)	LOG		

Alternative to Venture #515R; 3M #9420 & #9737R; Berry Global #756; Int'l Tape #713R; Scapa #5234R; Newbond #TF2404.

56" (1422mm) x 1200M Jumbos Available.

# Double Coated Polyester Tapes...

## DC-4123... Polyester (Clear) - Red PP Liner

7.5 mil exclusive of liner. 0.5 mil clear polyester film coated with a very aggressive, high tack, high shear **solvent based acrylic adhesive**. This product comes with a dimensionally stable Red PP release liner making it suitable for precision die-cut applications. It has excellent temperature, UV, aging, and water vapor resistance. Also has good plasticizer resistance. **Adhesion to SST: (1 min. dwell): 88 oz/in.** Temperature Resistance: up to 320°F long term, 356°F short term. Elongation: 100%. Tensile Strength: 14 lbs/in. Used for bonding, joining, laminating when high tack and high shear are critical. 3" neutral core/carton.

**Minimum 6 inches @ 1-2 case price +10%.**

54" (1372mm) x 700M Jumbos Available.

Also stocked in 180yd length @ 60yd proportional pricing.

WIDTH	RLS/CS	CASES		
		1-2	3-11	12+
<b>36 YD (33M)</b>				
3/8"	(9mm)	96		
1/2"	(12mm)	72		
3/4"	(18mm)	48		
1"	(24mm)	36		
1.5"	(36mm)	24		
2"	(48mm)	18		
3"	(72mm)	12		
54"	(1372mm)	LOG		

<b>60 YD (55M)</b>				
3/8"	(9mm)	96		
1/2"	(12mm)	72		
3/4"	(18mm)	48		
1"	(24mm)	36		
1.5"	(36mm)	24		
2"	(48mm)	18		
3"	(72mm)	12		
54"	(1372mm)	LOG		

Alternative to Tesa #4965, Lohman #373, Adchem #488M-PP-54.

# Double Coated Polypropylene Tapes...

## DC-1503... Polypropylene (Clear)

3.8 mil (0.097mm) exclusive of liner. 1.1 mil clear BOPP film coated on both sides with a **synthetic rubber resin adhesive**. Gold siliconized paper release liner. Solvent-free adhesive, ideal for fixing photographs. Used for core start-ups, splicing, holding, joining, attaching, mounting, and laminating applications. Good tack on flat surfaces. **Adhesion to SST: 73 oz/in (exposed side); 110 oz/in (liner side).** Tensile: 23 lbs/in. Elongation: 140%. Temperature Resistance: 140°F. 3" neutral core/carton.

53.5" (1360mm) x 1200M Jumbos Available.

WIDTH	RLS/CS	CASES		
		1-2	3-11	12+
<b>60 YD (55M)</b>				
3/8"	(9mm)	96 or 128		
1/2"	(12mm)	72 or 96		
3/4"	(18mm)	48 or 64		
1"	(24mm)	36 or 48		
1.5"	(36mm)	24 or 32		
2"	(48mm)	18 or 24		
3"	(72mm)	12 or 16		
53.5"	(1360mm)	LOG		

Alternative to Tesa #64621; Venture #1162, #1163; Sicad #700RDA; 3M #9576; Davik #DS4101; Boma #4140.

## DC-1511... Polypropylene (White)

4.3 mil (0.110mm) exclusive of liner. 2.0 mil white, non-oriented polypropylene coated on both sides with a high grade **hot melt rubber adhesive**. White siliconized paper release liner. High stretch for curved surfaces. High adhesion to paper, plastic and metal surfaces, excellent aging properties. Good adhesion to rough surfaces. Hand tearable. Economical carpet tape. **Adhesion to SST: 71 oz/in.** Tensile strength: 5 lbs/in. Elongation: 800%. Environmentally friendly; solventless adhesive. Temperature Resistance: -4°F to 140°F. 3" neutral core/carton.

54" (1370mm) x 900M to 1300M Jumbos Available.

<b>25 YD (23M)</b>				
1/2"	(12mm)	96		
3/4"	(18mm)	64		
1"	(24mm)	48		
1.5"	(36mm)	32		
2"	(48mm)	24		
3"	(72mm)	16		
54"	(1370mm)	LOG		

<b>36 YD (33M)</b>				
1/2"	(12mm)	96		
3/4"	(18mm)	64		
1"	(24mm)	48		
1.5"	(36mm)	32		
2"	(48mm)	24		
3"	(72mm)	16		
54"	(1370mm)	LOG		

Alternative to Int'l Tape #850; Tesa #64622.

## DC-3522... Polypropylene (Clear)

8.5 mil (0.215mm) exclusive of liner. 2.2 mil high performance clear polypropylene film coated on both sides with an age-resistant, **solvent based acrylic adhesive**. Gold siliconized paper liner. Extremely aggressive, ensuring permanency of the bond, even when exposed to elements (UV, humidity, solvents and chemicals). Bonds well to nearly all materials - metal, plastic, HSE, LSE, rough surfaces, etc. Used for mounting plastic/wood trims, fabrication of heavy decorative materials and displays, mounting transparent signs, bonding vinyl decals, and attaching plastic corner guards or extrusions. **Adhesion: 80 oz/in.** Temperature Resistance: -40°F to 248°F (320°F short term). 3" neutral core/carton.

54" (1372mm) x 600M Jumbos Available.

<b>55 YD (50M)</b>				
1/4"	(6mm)	144		
3/8"	(9mm)	96		
1/2"	(12mm)	72		
3/4"	(18mm)	48		
1"	(24mm)	36		
1.5"	(36mm)	24		
2"	(48mm)	18		
3"	(72mm)	12		
54"	(1372mm)	LOG		

Alternative to Tesa #51970.

**Minimum 6 inches @ 1-2 case price +10%.**

# Double Coated Tapes With Differential Adhesion...

## DC-3106R/P... Polyester (Clear)

2.3 mil exclusive of liner. 0.5 mil Clear polyester film **differentially coated with a low tack and high tack acrylic adhesive system**. The **liner side** is coated with a controlled, low tack, highly removable clear adhesive system which exhibits moderate adhesion to a variety of surfaces. The **exposed side** is coated with an aggressive, high tack, peel, shear, permanent acrylic adhesive. Performs well in low & moderate temperatures. Resistant to UV, moisture, some solvents, mild acids, oil & grease. Excellent adhesion to metals, glass, films, paper & some treated polyolefins. Used as a closure system for reclosable bags, pouches & envelopes, core start-ups and end tabbing of papers, foils and films; mounting displays that can easily be removed/replaced/repositioned; temporary laminating applications; making removable stickers & labels. **Adhesion to SST: 40 oz/in. (exposed), 16 oz/in (liner side)**. Elongation: 100%. Temperature Range: -40°F to 250°F. 3" neutral paper core/carton.

WIDTH	RLS/CS	CASES		
		1-2	3-11	12+
60 YD (55M)				
1/4"	(6mm)	144 or 192		
3/8"	(9mm)	96 or 128		
1/2"	(12mm)	72 or 96		
3/4"	(18mm)	48 or 64		
1"	(24mm)	36 or 48		
1.5"	(36mm)	24 or 32		
2"	(48mm)	18 or 24		
3"	(72mm)	12 or 16		
4"	(96mm)	12		
59"	(1500mm)	LOG		

59" (1500mm) x 1000Yd Jumbos Available.

## DC-665... Linerless/Repositionable (Clear)

3.5 mil (0.089mm). 3M™ Removable Repositionable Tape 665 is a clear, linerless tape with repositionable adhesive on a clear UPVC film carrier. Slight differential tack. Low temperature and medium solvent resistance. Excellent UV resistance & good solvent resistance. Good for a variety of lightweight materials like paper, photographic paper, foams, cardboard. For temporary mounting, adhering, attaching, temporary positioning and reclosable bags/envelopes. Used in the crafts, commercial, signage and arts industries. **Adhesion: 23 oz/in. (exposed), 25 oz/in (covered)**. Temperature Range: -60°F to 125°F. 3" 3M™ paper core.

WIDTH	x	**LENGTH	RLS/CS	* ROLL	CASE
1/2"	(12.7mm)	x	36 Yd	72	
1/2"	(12.7mm)	x	72 Yd		<b>DISCONTINUED / SOLD OUT</b>

\*MINIMUM ORDER SIX (6) ROLLS.

\*\* 36Yd rolls are individually packed in 3M™ retail box packaging.



# Double Coated Paper Tapes...

## DC-2306... Crepe Paper

6.0 mil (9.2 mil with liner). 3.5 mil high quality saturated crepe paper coated on both sides with a medium tack, high shear, synthetic copolymer **rubber based adhesive**. 60# white calendared siliconized paper liner. Good adhesion with excellent repositionability. Used for general purpose bonding of papers, films, fabrics, etc; splicing, core start ups; great for holding wood cuts & dies with little to no residue upon removal; and mounting golf club grip handles depending on lubricant type. Do NOT laminate/bond to materials containing migrating plasticizers. **Adhesion: 80 oz/in.** Tensile: 16 lbs/in. Elongation: 5%. Application Temp: 60°F to 120°F. Temp. Range: 0°F to 180°F. 3" neutral core/carton.

WIDTH	RLS/CS	CASES		
		1-2	3-11	12+
36 YD (33M)				
1/4"	(6mm)	192		
3/8"	(9mm)	128		
1/2"	(12mm)	96		
3/4"	(18mm)	64		
1"	(24mm)	48		
1.5"	(36mm)	32		
2"	(48mm)	24		
3"	(72mm)	16		
4"	(96mm)	12		
6"	(144mm)	8		
54"	(1372mm)	LOG		

Alternative to Int'l Tape #282; Adchem #262C; 3M #400.

## DC-2308... Crepe Paper

7.5 mil (10.7 mil with liner). 5 mil high quality saturated crepe paper, coated on both sides with an aggressive **synthetic rubber adhesive**, wound on a 3.2 mil super calendared, white siliconized paper liner. Used for core start-ups, splicing, holding, joining, attaching, mounting & laminating where high shear & high tack are required. Works well on irregular surfaces; holding wood cuts & dies; mounting rubber or plastic printing plates. Do NOT laminate/bond to materials containing migrating plasticizers. **Adhesion: 90 oz/in.** Tensile: 14 lbs/in. Elongation: 12%. Application Temp: 60°F to 120°F. Temp. Range: 0°F to 180°F. 3" neutral core/carton. 30" (762mm) x 1000M Jumbos Available.

36 YD (33M)				
1/4"	(6mm)	192		
3/8"	(9mm)	128		
1/2"	(12mm)	96		
3/4"	(18mm)	64		
1"	(24mm)	48		
1.5"	(36mm)	32		
2"	(48mm)	24		
3"	(72mm)	16		
4"	(96mm)	12		
6"	(144mm)	8		
30"	(762mm)	LOG		

Alternative to Int'l Tape #2280; Berry Global #60C6; 3M #410; Tesa #4961; Permaceal #P-05; Cantech #403-00.



# Double Coated Paper Tapes...



## DC-2315... Crepe Paper with Crepe Liner

6.0 mil (10.4 mil with liner). 4.3 mil crepe paper coated on both sides with an aggressive **natural rubber/resin adhesive** & wound with a white **crepe paper liner**. Good quick stick; great adhesive strength; bonds to most surfaces. Used in the printing industry, textile manufacturing (twisting/spinning process), steel rule die-makers/die-cutters (make-ready), & carpet installation. For bonding, mounting, holding, joining, core start-ups, and splicing applications. Used for repairing/replacing golf club grips. **Adhesion: 47 oz/in.** Quick Stick: 20 oz/in. Tensile: 23 lbs/in. Elongation: 8.5%. 3" neutral core/carton.

48" (1219mm) x 720YD Jumbos Available.

WIDTH	RLS/CS	CASES		
		1-2	3-11	12+
36 YD (33M)				
1/4"	(6mm)	192		
3/8"	(9mm)	128		
1/2"	(12mm)	96		
3/4"	(18mm)	64		
1"	(24mm)	48		
1.5"	(36mm)	32		
2"	(48mm)	24		
3"	(72mm)	16		
4"	(96mm)	12		
6"	(144mm)	8		
12"	(300mm)	4		
48"	(1219mm)	LOG		

Alternative to IPG #592; Shurtape #GG 200; #DF 63.

## DC-4309LW... Paper

3.5 mil exclusive of liner. 1.5 mil (0.35mm) white paper coated on both sides with a high tack **modified solvent free water based acrylic adhesive**; white 80 gr. siliconized paper liner. Adheres to nearly all materials, even difficult surfaces like foams & PE films. Very good temperature, UV, aging & water vapor resistance. Used for splicing, mounting, bonding, holding nameplates & laminating. **Adhesion (1 hr. dwell): 58.5 oz/in.** Elongation: 5%. Temp. Resistance: -40°F to +212°F. 3" neutral core/carton.

39.4" (1000mm) x 1000M Jumbos Available.

36 YD (33M)				
1/4"	(6mm)	144		
3/8"	(9mm)	96		
1/2"	(12mm)	72 or 96		
3/4"	(18mm)	48 or 64		
1"	(24mm)	36 or 48		
1.5"	(36mm)	24 or 32		
2"	(48mm)	18 or 24		
3"	(72mm)	12 or 16		
4"	(96mm)	12		
39.4"	(1000mm)	LOG		

## DC-4317VS... Paper

6.7 mil exclusive of liner. 4 mil white paper coated on both sides with an aggressive **modified solvent free water based acrylic adhesive**; gold siliconized paper liner. Good direct & durable adhesive strength; good dynamic & static shear strength. Good water vapor, temperature, UV & aging resistance. No plasticizer migration on most surfaces. Moderate chemical resistance (should be tested). Excellent corrugated splicing tape. Used for other holding, joining, attaching & laminating applications. **Adhesion (1 hr. dwell): 88 oz/in.** Elongation: 5%. Temp. Range: -40°F to 248°F. 3" neutral core/carton.

39.4" (1000mm) x 1000M Jumbos Available.

36 YD (33M)				
1/4"	(6mm)	144		
3/8"	(9mm)	96		
1/2"	(12mm)	72 or 96		
3/4"	(18mm)	48 or 64		
1"	(24mm)	36 or 48		
1.5"	(36mm)	24 or 32		
2"	(48mm)	18 or 24		
3"	(72mm)	12 or 16		
4"	(96mm)	12		
39.4"	(1000mm)	LOG		

## DC-2307... Flatback Paper

7.0 mil (12 mil with liner). Flatback paper coated on both sides with a high shear/aggressive **solvent based natural rubber resin adhesive**. White **crepe paper liner** allows for both automatic & hand dispensing applications. Bonds to most surfaces. Conforms well to rough & irregular surfaces. Excellent for installation of golf club grips. Meets spec CID A-A-180C, Type II (replaces UU-T-91E). **Adhesion: 52 oz/in.** Quick Stick: 20 oz/in. Unwind: 11 oz/in. Tensile: 34 lbs/in. Elongation: 3%. 3" neutral core/carton.

48" (1219mm) x 720YD Jumbos Available.

36 YD (33M)				
1/4"	(6mm)	144		
3/8"	(9mm)	96		
1/2"	(12mm)	72 or 96		
3/4"	(18mm)	48 or 64		
1"	(24mm)	36 or 48		
1.5"	(36mm)	24 or 32		
2"	(48mm)	24		
3"	(72mm)	16		
4"	(96mm)	12		
6"	(144mm)	8		
12"	(300mm)	4		
48"	(1219mm)	LOG		

Alternative to IPG #591; Tesa #4903; Shurtape #GG200; #DF65; Cantech #406-00.

Most of our items can be custom converted (other rolls widths and/or lengths). Contact us for details!

# Double Coated Tissue Tapes...

## DC-4210VS-B... Tissue (Black)

3.9 mil (0.10mm) exclusive of liner. 0.5 mil **black**, non-woven tissue coated on both sides with a modified, **solvent-free acrylic adhesive**, wound on a gold release liner. Exhibits a strong direct tack and continuous adhesive strength, as well as dynamic shear strength on most surfaces. No plasticizer migration on most surfaces. Excellent corrugators' splicing tape. Used in manufacturing for continuous web processes when a visual splice is needed. Good temperature, UV and aging resistance. **Adhesion (1 hr. dwell): 47.5 oz/in.** Elongation: 1%. Temperature Range: -40°F to 320°F. 3" neutral core/carton.

39.4" (1000mm) x 1000M Jumbos Available.

WIDTH	RLS/CS	CASES		
		1-2	3-11	12+
<b>60 YD (55M)</b>				
3/8"	(9mm)	128		
1/2"	(12mm)	96		
3/4"	(18mm)	64		
1"	(24mm)	48		
1.5"	(36mm)	32		
2"	(48mm)	24		
3"	(72mm)	16		
4"	(96mm)	12		
39.4"	(1000mm)	LOG		

## DC-4210RS... Tissue

3.9 mil (0.10mm) exclusive of liner. 0.5 mil white, non-woven tissue coated on both sides with a modified, solvent free **water based acrylic adhesive**, wound on a siliconized gold glassine 50# release liner. It exhibits good permanent adhesive strength as well as good static and dynamic shear properties on most surfaces, even when heat is applied. No plasticizer migration on most surfaces. Excellent corrugators' splicing tape. Made specifically for corrugated, heavy paper and film splicing; but also used for general holding, joining, attaching, and laminating applications. **Adhesion (1 hr. dwell): 36 oz/in.** Dynamic Shear: 48 lb/in<sup>2</sup>. Temperature Range: -40°F to + 392°F. 3" neutral core/carton.

59" (1500mm) x 800M Jumbos Available.

<b>55 YD (50M)</b>		
3/8"	(9mm)	128
1/2"	(12mm)	96
3/4"	(18mm)	64
1"	(24mm)	48
1.5"	(36mm)	32
2"	(48mm)	24
3"	(72mm)	16
4"	(96mm)	12
59"	(1500mm)	LOG

<b>110 YD (100M)</b>		
3/8"	(9mm)	128
1/2"	(12mm)	96
3/4"	(18mm)	64
1"	(24mm)	48
1.5"	(36mm)	32
2"	(48mm)	24
3"	(72mm)	16
59"	(1500mm)	LOG

Alternative to Tesa #4959, #50453 & #7158; Venture #585; Shurtape #DF-633; Scapa #5711; 3M #400, #404, #406.

## DC-4215WO... Tissue

5.9 mil (0.15mm) exclusive of liner. 0.5 mil white, non-woven tissue coated on both sides with an aggressive, modified solvent free **water based acrylic adhesive**, wound on a 50# siliconized gold glassine release liner. Provides a strong durable bond with good dynamic and static shear strength on most surfaces. Excellent adhesion to non-polar PE films and foams which are difficult surfaces to splice or laminate. Very resistant to humidity and weather when bonded. Very good temperature, UV, and aging resistance; however, tape exhibits moderate resistance against solvents. Superior conformability to irregular surfaces due to its heavy adhesive coat weight. Designed for heavy-duty splicing and permanent holding, with excellent performance on smooth or rough surfaces. Used for core start-ups, splicing of heavy webs such as wallpaper, holding, joining, attaching and mounting. **Adhesion: 84 oz/in.** Temperature Range: -40°F to 320°F. 3" neutral core/carton.

39.4" (1000mm) x 800M Jumbos Available.

<b>36 YD (33M)</b>		
3/8"	(9mm)	128
1/2"	(12mm)	96
3/4"	(18mm)	64
1"	(24mm)	48
1.5"	(36mm)	32
2"	(48mm)	24
3"	(72mm)	16
39.4"	(1000mm)	LOG

<b>60 YD (55M)</b>		
3/8"	(9mm)	128
1/2"	(12mm)	96
3/4"	(18mm)	64
1"	(24mm)	48
1.5"	(36mm)	32
2"	(48mm)	24
3"	(72mm)	16
39.4"	(1000mm)	LOG

**Most of our items can be custom converted (other rolls widths and/or lengths). Contact us for details!**

# Double Coated Tissue Tapes...

## DC-1210... Tissue

4.0 mil exclusive of liner. 1.8 mil tissue substrate coated on both sides with an aggressive synthetic **hot melt rubber adhesive**. 2.6 mil gold siliconized glassine paper release liner. Excellent quick stick & peel strength. Good for flying splice or static splicing where high resistance to heat is not required. Excellent for nameplates, trophies, core start-ups; laminating cork, cloth or felt; splicing papers, textiles, plastics. **Adhesion: 90 oz/in.** Tensile: 5.7 lbs/in. Operating Temperature: up to 140°F. Elongation: 5%. 3" neutral core/carton.

53.5" (1360mm) x 1200M Jumbos Available.

WIDTH	RLS/CS	CASES		
		1-2	3-11	12+
<b>60 YD (55M)</b>				
3/8"	(9mm)	128		
1/2"	(12mm)	96		
3/4"	(18mm)	64		
1"	(24mm)	48		
1.5"	(36mm)	32		
2"	(48mm)	24		
3"	(72mm)	16		
4"	(96mm)	12		
53.5"	(1360mm)	LOG		

Alternative to Tesa #4903; Int'l Tape #207; Venture #520; 3M #406; Adchem #2627; Sicad #710TNT; Boma #4150.



## DC-3208SA... Tissue

3.2 mil exclusive of liner. White, non-woven tissue carrier coated on both sides with a **solvent based acrylic adhesive**, wound on white PE coated paper liner. Quickly bonds to smooth surfaces like metal plates, films and plastics. Used to fix and laminate various substrates of electronic devices and components. For general holding, attaching, joining, and laminating application. Rolling Ball Tack: ≤100mm. **Adhesion: 54 oz/in.** Application Temperature: 50°F to 105°F. Temperature Resistance: up to 248°F. 3" neutral core/carton.

48.8" (1240mm) x 1250M Jumbos Available.

Replaces DC-3206SA (same/proportional cost).

<b>55 YD (50M)</b>				
3/8"	(9mm)	128		
1/2"	(12mm)	96		
3/4"	(18mm)	64		
1"	(24mm)	48		
1.5"	(36mm)	32		
2"	(48mm)	24		
3"	(72mm)	16		
4"	(96mm)	12		
48.8"	(1240mm)	LOG		

<b>110 YD (100M)</b>				
1/2"	(12mm)	96		
3/4"	(18mm)	64		
1"	(24mm)	48		
1.5"	(36mm)	32		
2"	(48mm)	24		
3"	(72mm)	16		
48.8"	(1240mm)	LOG		

Alternative to IPG #DCT101A; V. Himark #F2410.



## DC-3212SA... Tissue

4.7 mil exclusive of liner. White, non-woven tissue carrier coated on both sides with a **solvent based acrylic adhesive**, wound on a siliconized gold glassine paper release liner. It exhibits good permanent adhesive strength as well as good static and dynamic shear properties on most surfaces, even when heat is applied. No plasticizer migration on most surfaces. Perfect for splicing of plastic film, paper and foil of industrial grade. Excellent corrugators' flying splice tape. Can also be used for general holding, joining, attaching, and laminating applications. Rolling Ball Tack: ≤50m. **Adhesion: 83 oz/in.** Application Temperature: 50°F to 105°F. Temperature Resistance: up to 248°F. 3" neutral core/carton.

47.2" (1200mm) x 1000M Jumbos Available.

Replaces DC-3210SA (same/proportional cost).

<b>55 YD (50M)</b>				
3/8"	(9mm)	128		
1/2"	(12mm)	96		
3/4"	(18mm)	64		
1"	(24mm)	48		
1.5"	(36mm)	32		
2"	(48mm)	24		
3"	(72mm)	16		
4"	(96mm)	12		
47.2"	(1200mm)	LOG		

<b>110 YD (100M)</b>				
1/2"	(12mm)	96		
3/4"	(18mm)	64		
1"	(24mm)	48		
1.5"	(36mm)	32		
2"	(48mm)	24		
3"	(72mm)	16		
47.2"	(1200mm)	LOG		

Alternative to Tesa #7158, #50658, #4959, #50605; Shurtape DT200; 3M #469; Achem DT63Q; V. Himark #L2450.

# Double Coated Cloth Tapes...

CASES

WIDTH RLS/CS 1-2 3-11 12+

## DC-5215... Polyester Fabric Tape

6.1 mil exclusive of liner. Double coated tape with a white polyester fabric backing and a **white synthetic rubber adhesive**. The product has an easy release, gold siliconized paper liner. Good tack & aggressive adhesion; bonds well to various surfaces & shapes. Suitable for use on most carpets and floorings. Hand-tearable and highly conformable. Not resistant to plasticizers. **Adhesion to Steel: 91 oz/in (exposed side); 73 oz/in (liner side)**. Tensile Strength: 15 lbs/in. Elongation 10%. Temperature Resistance: 140°F. 3" neutral core/carton.

53.5" (1360mm) x 800M Jumbos Available.

25 YD (23M)		
1/2"	(12mm)	72 or 96
3/4"	(18mm)	48 or 64
1"	(24mm)	36 or 48
1.5"	(36mm)	24 or 32
2"	(48mm)	18 or 24
3"	(72mm)	12 or 16
4"	(96mm)	12
53.5"	(1360mm)	LOG

36 YD (33M)		
1/2"	(12mm)	72 or 96
3/4"	(18mm)	48 or 64
1"	(24mm)	36 or 48
1.5"	(36mm)	24 or 32
2"	(48mm)	18 or 24
3"	(72mm)	12 or 16
4"	(96mm)	12
53.5"	(1360mm)	LOG

## DC-5225... Polyester Fabric Tape

9.3 mil exclusive of liner. White polyester fabric coated on both sides with a white, aggressive **synthetic hot melt rubber adhesive**. Gold siliconized paper liner. High tack & excellent adhesion; ideal for use on rough surfaces. Used for laying carpet, fixing & splicing of textiles, securing polyethylene film to brick & cinder block walls, other general mounting on rough or fibrous surfaces. Provides additional support during prepping applications of abatement areas. Hand-tearable. Not plasticizer resistant. **Adhesion to Steel: 128 oz/in (exposed side); 99 oz/in (liner side)**. Tensile Strength: 18 lbs/in. Elongation 15%. Temperature Resistance: 140°F. 3" neutral core/carton.

53.5" (1360mm) x 650M Jumbos Available.

25 YD (23M)		
1/2"	(12mm)	72 or 96
3/4"	(18mm)	48 or 64
1"	(24mm)	36 or 48
1.5"	(36mm)	24 or 32
2"	(48mm)	18 or 24
3"	(72mm)	12 or 16
4"	(96mm)	12
53.5"	(1360mm)	LOG

36 YD (33M)		
1/2"	(12mm)	72 or 96
3/4"	(18mm)	48 or 64
1"	(24mm)	36 or 48
1.5"	(36mm)	24 or 32
2"	(48mm)	18 or 24
3"	(72mm)	12 or 16
4"	(96mm)	12
53.5"	(1360mm)	LOG

Alternative to Tesa #4934; Shurtape #DF-642; Int'l Tape #319; Sicaad #730-GDA; Venture #581.

## DC-5227X... Exhibition Carpet Tape. Removable.

11 mil exclusive of liner. Natural colored cotton/polyester blended cloth coated on both sides with a high shear, moderate tack **natural rubber based adhesive. Residue free.** Blue silicone coated polyethylene release liner allows for complete, tear free liner pull and removal. Used for carpet hold-down and other general purpose uses in aircraft mfg. Used extensively in the convention and trade show industry as it will leave no adhesive residue upon removal from most substrates. **Adhesion to Steel: 40 oz/in.** Tensile Strength: 20 lbs/in. 3" neutral core/carton.

60" (1524mm) x 684 Yd Jumbos Available.

25 YD (23M)		
1"	(24mm)	48
1.5"	(36mm)	32
2"	(48mm)	24
3"	(72mm)	16
4"	(96mm)	12
60"	(1524mm)	LOG

36 YD (33M)		
1"	(24mm)	48
1.5"	(36mm)	32
2"	(48mm)	24
3"	(72mm)	16
4"	(96mm)	12
60"	(1524mm)	LOG

Alternative to Berry Global #105C.

## DC-5230X... Exhibition Carpet Tape. Removable.

12 mil exclusive of liner. Natural colored woven cotton cloth coated on both sides with a moderate tack **natural rubber based adhesive system.** White silicone coated polyethylene release liner allows for easy removal. Hand Tearable. Used for industrial and commercial carpet hold-down and other general purpose applications. It is used primarily in the convention/trade show industry, as it will leave little to no adhesive residue upon removal from the substrate. **Peel Adhesion: 40 oz/in.** Tensile Strength: 28 lbs/in. Temperature Resistance: 140°F. 3" neutral core/carton.

57" (1448mm) x 450 Yd Jumbos Available.

25 YD (23M)		
1"	(24mm)	48
1.5"	(36mm)	32
2"	(48mm)	24
3"	(72mm)	16
4"	(96mm)	12
57"	(1448mm)	LOG

36 YD (33M)		
1"	(24mm)	48
1.5"	(36mm)	32
2"	(48mm)	24
3"	(72mm)	16
4"	(96mm)	12
57"	(1448mm)	LOG

Alternative to Scapa #274.

# Double Coated Scrim Tape...

## DC-4608MF... Double Coated Scrim Tape

3.15 mil exclusive liner. An aggressive clear PES/PVA scrim coated on both sides with a modified **solvent free water based acrylic adhesive**. Gold 90 gr. siliconized paper release liner. The adhesive system of this double coated tape has excellent tack combined with high adhesive strength. Bond well to nearly all materials, even to difficult surfaces like foams, PE and PP films. APEO/APE Free. Hand tearable. Excellent temperature, UV, aging and water vapor resistance. Acrylic adhesive provides long term performance. Scrim reinforcement provides for improved lay down. Used for permanent bonding of various materials such as fabrics, wallboard, plastic, metal and wood surfaces. Used for laminating foams and films. Used to make frames self-adhesive.

**Adhesion: 76 oz./in.** Temperature Resistance: -40°F to 194°F. 3" neutral core/carton.

39.4" (1000mm) x 800M Jumbos Available.

54" (1371mm) x 800M Jumbos Available.

## DC-4623MF... Heavy-Duty Scrim Tape

9.1 mil exclusive of liner. Thick polyester reinforced transfer tape (PES/PVA Scrim) with an aggressive, modified **solvent free water based acrylic adhesive**. Gold 90 gr. siliconized paper release liner. The adhesive system is extremely aggressive, and will bond well to nearly all materials; even to difficult surfaces like foam, PE and PP films. It has good temperature, UV, aging, and water vapor resistance. Used for permanent bonding of plastic, metal and wood (P.M.W.) surfaces. APEO/APE Free. Primarily designed for use in bonding carpet and plastic baseboard molding to walls, ceilings, modular units, etc. **Adhesion: 120 oz./in.** Temperature Resistance: -40°F to 194°F. 3" neutral core/carton.

39.4" (1000mm) x 800M Jumbos Available.

54" (1371mm) x 800M Jumbos Available.



WIDTH	RLS/CS	CASES		
		1-2	3-11	12+
<b>36 YD (33M)</b>				
1/2"	(12mm)	96		
3/4"	(18mm)	64		
1"	(24mm)	48		
1.5"	(36mm)	32		
2"	(48mm)	24		
3"	(72mm)	16		
39.4"	(1000mm)	LOG		
54"	(1371mm)	LOG		
<b>60 YD (55M)</b>				
1/2"	(12mm)	72		
3/4"	(18mm)	48		
1"	(24mm)	36		
1.5"	(36mm)	24		
2"	(48mm)	18		
3"	(72mm)	12		
39.4"	(1000mm)	LOG		
54"	(1371mm)	LOG		
<b>227M</b>				
39.4"	(1000mm)	LOG		
54"	(1371mm)	LOG		

<b>25 YD (23M)</b>				
3/8"	(9mm)	128		
1/2"	(12mm)	96		
3/4"	(18mm)	64		
1"	(24mm)	48		
1.5"	(36mm)	32		
2"	(48mm)	24		
3"	(72mm)	16		
39.4"	(1000mm)	LOG		
54"	(1371mm)	LOG		
<b>36 YD (33M)</b>				
3/8"	(9mm)	96		
1/2"	(12mm)	72		
3/4"	(18mm)	48		
1"	(24mm)	36		
1.5"	(36mm)	24		
2"	(48mm)	18		
3"	(72mm)	12		
39.4"	(1000mm)	LOG		
54"	(1371mm)	LOG		
<b>55 YD (50M)</b>				
3/4"	(18mm)	48		
1"	(24mm)	36		
1.5"	(36mm)	24		
2"	(48mm)	18		
39.4"	(1000mm)	LOG		
54"	(1371mm)	LOG		

Most of our items can be custom converted (other rolls widths and/or lengths). Contact us for details!

# Ultra High Bond Tapes...

## Double Coated Acrylic Foam

This is a foamed acrylic system with a special composition giving excellent all around bonding properties and unique characteristics that allows for very high performance in the most demanding of applications. The pressure sensitive acrylic composition provides for very good tack, excellent adhesion to a variety of surfaces and high shear strength performance. Tape is carried on a **RED release coated polyethylene liner** that is easily removed.

### FA-UHB10C... CLEAR Foamed Acrylic Tape

9.8mils (0.25mm) exclusive of liner. Clear foamed acrylic with RED PE liner. Ideal for structural bonding applications to mount/fix car side molding and emblems. Used as a mounting tape in the illuminated sign industry, for fabricating road signs, joining of metals and plastic trims in furniture construction and architectural applications. **180° Peel Adhesion: 100.8 oz/in.** Tensile: 107 lb/in<sup>2</sup>. Dynamic Shear: 85 lb/in<sup>2</sup>. Temperature Resistance: -40°F to 302°F (up to 482°F short term). UV Resistance: Good. 3" plastic core.

WIDTH		RLS/CS	* ROLL	CASE
36 YD (108 FT) 33M				
1/4"	(6.3mm)	48		
3/8"	(9.5mm)	32		
1/2"	(12.7mm)	24		
3/4"	(19.0mm)	16		
1"	(25.4mm)	12		
31.5"	(800.0mm)	LOG		

Alternative to 3M #9473; Hi-Bond #4025C; ORABOND #3596.

### FA-UHB10B... BLACK Foamed Acrylic Tape

9.8mils (0.25mm) exclusive of liner. Black foamed acrylic with a special composition giving excellent all around bonding properties and unique characteristics that allows for very high performance in the most demanding of applications. The pressure sensitive acrylic composition provides for very good tack, excellent adhesion to variety of surfaces and high shear strength performance. Tape is carried on a RED, release coated polyethylene liner that is easily removed. **180° Peel Adhesion: 110.4 oz/in.** Tensile: 111 lb/in<sup>2</sup>. Dynamic Shear: after 20 mins. 71 lb/in<sup>2</sup>; after 24 hours: 107 lb/in<sup>2</sup>. Temperature Resistance: -40°F to 212°F (up to 320°F short term). UV Resistance: Good. 3" plastic core.

WIDTH		RLS/CS	* ROLL	CASE
72 YD (216 FT) 66M				
1/4"	(6.3mm)	48		
3/8"	(9.5mm)	32		
1/2"	(12.7mm)	24		
3/4"	(19.0mm)	16		
1"	(25.4mm)	12		
31.5"	(800.0mm)	LOG		

Alternative to 3M #4920; Hi-Bond #6025B.

### FA-UHB16W... WHITE Foamed Acrylic Tape

15.7mils (0.40mm) exclusive of liner. White foamed acrylic with RED PE liner. Perfect for bonding components in the electronics industries, such as computers, consumer electronics, white goods, bonding thin sheet metal and plastics. **180° Peel Adhesion: 124.8 oz/in.** Tensile: 156 lb/in<sup>2</sup>. Dynamic Shear: 114 lb/in<sup>2</sup>. Temperature Resistance: -40°F to 212°F (up to 320°F short term). UV Resistance: Good. 3" plastic core.

WIDTH		RLS/CS	* ROLL	CASE
72 YD (216 FT) 66M				
1/4"	(6.3mm)	48		
3/8"	(9.5mm)	32		
1/2"	(12.7mm)	24		
3/4"	(19.0mm)	16		
1"	(25.4mm)	12		
31.5"	(800.0mm)	LOG		

Alternative to 3M #4920; Hi-Bond #4040W.

### FA-UHB16E... GRAY Foamed Acrylic Tape

15.7mils (0.40mm) exclusive of liner. Gray foamed acrylic with a special composition giving excellent all around bonding properties and unique characteristics that allows for very high performance in the most demanding of applications. The pressure sensitive acrylic composition provides for very good tack, excellent adhesion to variety of surfaces and high shear strength performance. Tape is carried on a RED, release coated polyethylene liner that is easily removed. **180° Peel Adhesion: 118.4 oz/in.** Tensile: 107 lb/in<sup>2</sup>. Dynamic Shear: after 20 min: 64 lb/in<sup>2</sup>; after 24 hours: 100 lb/in<sup>2</sup>. Temperature Resistance: -40°F to 212°F (up to 320°F short term). UV Resistance: Good. 3" plastic core.

WIDTH		RLS/CS	* ROLL	CASE
72 YD (216 FT) 66M				
1/4"	(6.3mm)	48		
3/8"	(9.5mm)	32		
1/2"	(12.7mm)	24		
3/4"	(19.0mm)	16		
1"	(25.4mm)	12		
31.5"	(800.0mm)	LOG		

Alternative to 3M #4920; Hi-Bond #6040G.

**\* NOTE: For all UHB products, MINIMUM 3" per item or 10% surcharge will be added to roll price.**

# Ultra High Bond Tapes...

## Double Coated Acrylic Foam

### FA-UHB20C... CLEAR Foamed Acrylic Tape

19.7mils (0.50mm) exclusive of liner. Clear foamed acrylic adhesive with RED PE liner. Used as a mounting tape in the illuminated sign industry, for fabricating road signs, joining of metals and plastic trims in furniture construction and architectural applications. **180° Peel Adhesion: 75.2 oz/in.** Tensile: 100 lb/in<sup>2</sup>. Dynamic Shear: 78 lb/in<sup>2</sup>. Temperature Resistance: -40°F to 194°F (up to 302°F short term). UV Resistance: Good. 3" plastic core.

WIDTH	RLS/CS	* ROLL	CASE
36 YD (108 FT) 33M			
1/4"	(6.3mm)	48	
3/8"	(9.5mm)	32	
1/2"	(12.7mm)	24	
3/4"	(19.0mm)	16	
1"	(25.4mm)	12	
31.5"	(800.0mm)	LOG	

Alternative to 3M #4905; Hi-Bond #4050C; ORABOND #3597.

### FA-UHB25W... WHITE Foamed Acrylic Tape

25.2mils (0.64mm) exclusive of liner. White foamed acrylic adhesive with RED PE liner. Ideal for structural bonding applications to mount/fix car side molding and emblems. Bonding of metal furniture, cabinets, lockers, plastic extrusion fixing. **180° Peel Adhesion: 147.2 oz/in.** Tensile: 149 lb/in<sup>2</sup>. Dynamic Shear: 102 lb/in<sup>2</sup>. Temperature Resistance: -40°F to 212°F (up to 320°F short term). UV Resistance: Good. 3" plastic core.

WIDTH	RLS/CS	* ROLL	CASE
36 YD (108 FT) 33M			
1/4"	(6.3mm)	48	
3/8"	(9.5mm)	32	
1/2"	(12.7mm)	24	
3/4"	(19.0mm)	16	
1"	(25.4mm)	12	
31.5"	(800.0mm)	LOG	

Alternative to 3M #4930, #4930F; Hi-Bond #4064W; ORABOND #3595.

### FA-UHB25E... GRAY Foamed Acrylic Tape

25.2mils (0.64mm) exclusive of liner. Gray foamed acrylic adhesive with a special composition giving excellent all around bonding properties and unique characteristics that allow for very high performance in the most demanding of applications. **180° Peel Adhesion: 120 oz/in.** Tensile: 108 lb/in<sup>2</sup>. Dynamic Shear: 102 lb/in<sup>2</sup>. Temperature Resistance: -40°F to 212°F (up to 320°F short term). UV Resistance: Good. 3" plastic core.

WIDTH	RLS/CS	* ROLL	CASE
36 YD (108 FT) 33M			
1/4"	(6.3mm)	48	
3/8"	(9.5mm)	32	
1/2"	(12.7mm)	24	
3/4"	(19.0mm)	16	
1"	(25.4mm)	12	
31.5"	(800.0mm)	LOG	

Alternative to 3M #4936, #4936F, #4919F, #5925, #4929, #4646, RP25; Hi-Bond #6064G; ORABOND #3594.

### FA-UHB31E... GRAY Foamed Acrylic Tape

31.5mils (0.8mm) exclusive of liner. Gray foamed acrylic adhesive with a special composition giving excellent all around bonding properties and unique characteristics that allows for very high performance in the most demanding of applications. **180° Peel Adhesion: 132.8 oz/in.** Tensile: 92 lb/in<sup>2</sup>. Dynamic Shear: 92 lb/in<sup>2</sup>. Temperature Resistance: -40°F to 212°F (up to 320°F short term). UV Resistance: Good. 3" plastic core.

WIDTH	RLS/CS	* ROLL	CASE
36 YD (108 FT) 33M			
1/4"	(6.3mm)	48	
3/8"	(9.5mm)	32	
1/2"	(12.7mm)	24	
3/4"	(19.0mm)	16	
1"	(25.4mm)	12	
31.5"	(800.0mm)	LOG	

Alternative to 3M #5314, #4214, #5345, #5665; ADCO #AT-6030; Hi-Bond #6080G; ORABOND #3598.

### FA-UHB40C... CLEAR Foamed Acrylic Tape

39.4mils (1.0mm) exclusive of liner. Clear foamed acrylic adhesive with RED PE liner. Used in the manufacture of laminated safety glass and hurricane impact glass. Bonding, sealing and fixing of shower screens, cubicle glass and plastic, glass display cabinets, refrigerated cabinets for supermarkets and chilled drink cabinets. **180° Peel Adhesion: 96 oz/in.** Tensile: 100 lb/in<sup>2</sup>. Dynamic Shear: 70 lb/in<sup>2</sup>. Temperature Resistance: -40°F to 194°F (up to 302°F short term). UV Resistance: Good. 3" plastic core.

WIDTH	RLS/CS	* ROLL	CASE
36 YD (108 FT) 33M			
1/4"	(6.3mm)	48	
3/8"	(9.5mm)	32	
1/2"	(12.7mm)	24	
3/4"	(19.0mm)	16	
1"	(25.4mm)	12	
31.5"	(800.0mm)	LOG	

Alternative to 3M #4910; Hi-Bond #4100C; ORABOND #3599.

**\* NOTE: For all UHB products, MINIMUM 3" per item or 10% surcharge will be added to roll price.**

# Double Coated Acrylic Foam

## FA-UHB45E... GRAY Foamed Acrylic Tape

43.3mils (1.1mm) exclusive of liner. Gray foamed acrylic adhesive; RED PE liner. Ideal for structural bonding applications in the transportation industry. Used in automotive aftermarket industry, in body shops for crash repair, mounting/fixing car side molding and emblems. **180° Peel Adhesion: 139.2 oz/in.** Tensile: 85 lb/in<sup>2</sup>. Dynamic Shear: 85 lb/in<sup>2</sup>. Temperature Resistance: -40°F to 212°F (up to 320°F short term). UV Resistance: Good. 3" plastic core.

## FA-UHB45W... WHITE Foamed Acrylic Tape

43.3mils (1.1mm) exclusive of liner. White foamed acrylic adhesive; RED PE liner. Ideal for structural bonding applications in the transportation industry. Bonding of plastic & wooden window glazing bars, fixing architectural cladding panels. **180° Peel Adhesion: 161.6 oz/in.** Tensile: 141 lb/in<sup>2</sup>. Dynamic Shear: 81 lb/in<sup>2</sup>. Temperature Resistance: -40°F to 212°F (up to 320°F short term). UV Resistance: Good. 3" plastic core.

## FA-UHB60C... CLEAR Foamed Acrylic Tape

59.1mils (1.5mm) exclusive of liner. Clear foamed acrylic; RED PE liner. Ideal for all around bonding in the most demanding applications. **180° Peel Adhesion: 118.4 oz/in.** Tensile: 85 lb/in<sup>2</sup>. Dynamic Shear: 57 lb/in<sup>2</sup>. Temperature Resistance: -40°F to 194°F (up to 302°F short term). UV Resistance: Good. 3" plastic core.

## FA-UHB60E... GRAY Foamed Acrylic Tape

59.1mils (1.5mm) exclusive of liner. Gray foamed acrylic adhesive; RED PE liner. Ideal for all around bonding in the most demanding applications. **180° Peel Adhesion: 139.2 oz/in.** Tensile: 78 lb/in<sup>2</sup>. Dynamic Shear: 78 lb/in<sup>2</sup>. Temperature Resistance: -40°F to 212°F (up to 320°F short term). UV Resistance: Good. 3" plastic core.

## FA-UHB80W... WHITE Foamed Acrylic Tape

78.2mils (2.0mm) exclusive of liner. White foamed acrylic adhesive; RED PE liner. Ideal for all around bonding in the most demanding applications. **180° Peel Adhesion: 124.8 oz/in.** Tensile: 93 lb/in<sup>2</sup>. Dynamic Shear: 79 lb/in<sup>2</sup>. Temperature Resistance: -40°F to 212°F (up to 320°F short term). UV Resistance: Good. 3" plastic core.

## FA-UHB80E... GRAY Foamed Acrylic Tape

78.8mils (2.0mm) exclusive of liner. Gray foamed acrylic adh.; RED PE liner. Ideal for structural bonding applications in the transportation industry - fixing body & roof panels in the bus & truck industry, mounting/fixing car side molding & emblems. **180° Peel Adhesion: 139.2 oz/in.** Tensile: 71 lb/in<sup>2</sup>. Dynamic Shear: After 20 min: 43 lb/in<sup>2</sup>; after 24 hours: 75 lb/in<sup>2</sup>. Temperature Resistance: -40°F to 212°F (up to 320°F short term). UV Resistance: Good. 3" plastic core.

## FA-UHB120W... WHITE Foamed Acrylic Tape

118mils (3.0mm) exclusive of liner. White foamed acrylic adhesive; RED PE liner. Ideal for structural bonding applications in the transportation industry - i.e. fixing body and roof panels in the bus and truck industry, mounting/fixing car side molding and emblems. **180° Peel Adhesion: 107.2 oz/in.** Tensile: 85 lb/in<sup>2</sup>. Dynamic Shear: 64 lb/in<sup>2</sup>. Temperature Resistance: -40°F to 212°F (up to 320°F short term). UV Resistance: Good. 3" plastic core.

WIDTH	RLS/CS	* ROLL	CASE
<b>36 YD (108 FT) 33M</b>			
1/4"	(6.3mm)	48	
3/8"	(9.5mm)	32	
1/2"	(12.7mm)	24	
3/4"	(19.0mm)	16	
1"	(25.4mm)	12	
31.5"	(800.0mm)	LOG	

Alternative to 3M #4941, #4941F, #4947F, #4949, #4611, #5344, #5605, #5952; ADCO #1140; Hi-Bond #6110G; ORABOND #3600.

WIDTH	RLS/CS	* ROLL	CASE
<b>36 YD (108 FT) 33M</b>			
1/4"	(6.3mm)	48	
3/8"	(9.5mm)	32	
1/2"	(12.7mm)	24	
3/4"	(19.0mm)	16	
1"	(25.4mm)	12	
31.5"	(800.0mm)	LOG	

Alternative to 3M #4622, #4945, #4946, #4950; Hi-Bond #4110W; ORABOND #3601.

WIDTH	RLS/CS	* ROLL	CASE
<b>27.34 YD (82 FT) 25M</b>			
1/4"	(6.3mm)	48	
3/8"	(9.5mm)	32	
1/2"	(12.7mm)	24	
3/4"	(19.0mm)	16	
1"	(25.4mm)	12	
31.5"	(800.0mm)	LOG	

Alternative to 3M #4915; ADCO #1160; Hi-Bond #4150C.

WIDTH	RLS/CS	* ROLL	CASE
<b>27.34 YD (82 FT) 25M</b>			
1/4"	(6.3mm)	48	
3/8"	(9.5mm)	32	
1/2"	(12.7mm)	24	
3/4"	(19.0mm)	16	
1"	(25.4mm)	12	
31.5"	(800.0mm)	LOG	

Alternative to 3M #4956, #4979F, #5356, #5567 #5962; ADCO #4655, #4956; Hi-Bond #6150G; ORABOND #3603.

WIDTH	RLS/CS	* ROLL	CASE
<b>18 YD (54 FT) 16.5M</b>			
1/4"	(6.3mm)	48	
3/8"	(9.5mm)	32	
1/2"	(12.7mm)	24	
3/4"	(19.0mm)	16	
1"	(25.4mm)	12	
31.5"	(800.0mm)	LOG	

Alternative to 3M #4912; ADCO #4955; Hi-Bond #4200W.

WIDTH	RLS/CS	* ROLL	CASE
<b>18 YD (54 FT) 16.5M</b>			
1/4"	(6.3mm)	48	
3/8"	(9.5mm)	32	
1/2"	(12.7mm)	24	
3/4"	(19.0mm)	16	
1"	(25.4mm)	12	
31.5"	(800.0mm)	LOG	

Alternative to 3M #4991; Hi-Bond #6200G; ORABOND #3602.

WIDTH	RLS/CS	* ROLL	CASE
<b>18 YD (54 FT) 16.5M</b>			
1/4"	(6.3mm)	48	
3/8"	(9.5mm)	32	
1/2"	(12.7mm)	24	
3/4"	(19.0mm)	16	
1"	(25.4mm)	12	
31.5"	(800.0mm)	LOG	

Alternative to 3M #4959; Hi-Bond #6300W.

**\* NOTE: For all UHB products, MINIMUM 3" per item or 10% surcharge will be added to roll price.**



# Ultra High Bond Tapes...

## Acrylic Transfer Tapes (AT-UHB mil thickness) & Double Coated (DC-UHB mil thickness)

Ultra High Bond Acrylic Adhesive Tapes are carried on a 7 mil white polyethylene release liner. Tape bonds to most surfaces, but thorough evaluation is recommended when bonding on low energy surface materials such as PVC, ABS, PE, PP. Not recommended for bonding Teflon™, Tedlar™, Silicone or EPDM. Temperature Range: -30°F to 200°F. Application Temperature: 50°F to 100°F. 3" plastic core.

**AT-UHB (mil thickness)** This structural grade **solid acrylic adhesive transfer** system has been skillfully engineered to provide a strong, moistureproof bond between various substrates. It is flexible, moldable, & compressible. Due to its clarity, can be used to bond glass and other clear materials. Bonds permanently to most clean, dry, oil-free, non-porous surfaces, including aluminum, stainless steel, glass, painted metal, and many others. Used in attachment of dissimilar surfaces. Used for auto and truck trim attachment; in aviation, marine, electronics, furniture, signage & appliance industries. Applications: replacing mechanical fasteners, bonding nameplates & decorative trim; window fabrication - standard and high impact resistant; bonding/seaming metal in electrical panels, HVAC units; fabrication of bullet proof products. Maintains bond at sub-zero temperature. Excellent UV, solvent & moisture resistance (Note: as with similar products, tape will yellow when exposed to UV, but performance is not affected). COLOR: WATER CLEAR.

**DC-UHB (mil thickness)** This structural grade tape is comprised of an integral core of **solid acrylic polymer**, coated on both sides with a uniform high-tack acrylic adhesive. Provides a superior, permanent bond between a wide variety of substrates, including glass, some plastics, composites, sealed wood, metals and painted metals. Applications: rugged metal to metal bonds to replace welding, rivets, bolts, screw and cementing; signs, graphic arts assemblies; furniture/appliance mfg, RV skin to frame assembly. Withstands a wide range of weathering and temperature conditions without losing adhesion. Non-staining, will not harden/become brittle with age. Maintains adhesion at sub-zero temperatures. Solid acrylic core gives tape superior strength, can be easily applied and cleanly cut, yet is flexible, moldable, compressible & conformable to intricate shapes. Solid core is key for structural assembly, used primarily in transportation industry, automotive, truck, trailer & bus, OEM & aftermarket, as it isolates and dampens vibration and shock. DC-UHB45 approved for certain GM, Ford and Chrysler specifications. COLOR: TRANSLUCENT.

WIDTH	RLS/CS	* ROLL	CASE
<b>AT-UHB10</b>	10 mil.		60 YD (55M)
1/4"	(6.3mm)	48	
3/8"	(9.5mm)	32	
1/2"	(12.7mm)	24	
3/4"	(19.0mm)	16	
1"	(25.4mm)	12	
18"	(457.0mm)	LOG	

Alternative to 3M #9473; ADCO #AT-1010-457A; Hi-Bond #VST-4025C.

WIDTH	RLS/CS	* ROLL	CASE
<b>DC-UHB25</b>	25 mil.		72 YD (66M)
1/4"	(6.3mm)	48	
3/8"	(9.5mm)	32	
1/2"	(12.7mm)	24	
3/4"	(19.0mm)	16	
1"	(25.4mm)	12	
18"	(457.0mm)	LOG	

Alternative to 3M #4925, #4929, #4930, #4936; ADCO #AT-3125-457A; SCAPA #S5300A; Hi-Bond #VST-6025G.

WIDTH	RLS/CS	* ROLL	CASE
<b>AT-UHB40</b>	40 mil.		36 YD (33M)
1/4"	(6.3mm)	48	
3/8"	(9.5mm)	32	
1/2"	(12.7mm)	24	
3/4"	(19.0mm)	16	
1"	(25.4mm)	12	
18"	(457.0mm)	LOG	

Alternative to 3M #4910; ADCO #AT-1140-457A; Hi-Bond #VST-4100C.

WIDTH	RLS/CS	* ROLL	CASE
<b>DC-UHB45</b>	45 mil.		36 YD (33M)
1/4"	(6.3mm)	48	
3/8"	(9.5mm)	32	
1/2"	(12.7mm)	24	
3/4"	(19.0mm)	16	
1"	(25.4mm)	12	
18"	(457.0mm)	LOG	

Alternative to 3M #4940, #4943, #4949, #4950, #6381 to #6384 (retail); ADCO #AT-3145-457A; SCAPA S5300B; Hi-Bond #VST-6110W.

WIDTH	RLS/CS	* ROLL	CASE
<b>AT-UHB60</b>	60 mil.		36 YD (33M)
1/4"	(6.3mm)	48	
3/8"	(9.5mm)	32	
1/2"	(12.7mm)	24	
3/4"	(19.0mm)	16	
1"	(25.4mm)	12	
18"	(457.0mm)	LOG	

**DISCONTINUED**

WIDTH	RLS/CS	* ROLL	CASE
<b>DC-UHB60</b>	60 mil.		36 YD (33M)
1/4"	(6.3mm)	48	
3/8"	(9.5mm)	32	
1/2"	(12.7mm)	24	
3/4"	(19.0mm)	16	
1"	(25.4mm)	12	
18"	(457.0mm)	LOG	

Alternative to 3M #4957; ADCO #AT-3060-457A; SCAPA S5300C; Hi-Bond #VST-6150G.

NOTE: AT-UHB60, DC-UHB60 & DC-UHB80 are available as a special, non-cancellable order; full web width must be taken.

WIDTH	RLS/CS	* ROLL	CASE
<b>DC-UHB80</b>	80 mil.		36 YD (33M)
1/4"	(6.3mm)	48	
3/8"	(9.5mm)	32	
1/2"	(12.7mm)	24	
3/4"	(19.0mm)	16	
1"	(25.4mm)	12	
18"	(457.0mm)	LOG	

**DISCONTINUED**

### Physical Properties...

Specific Gravity	1.04
Tensile Strength	150 psi
Elongation	1000%
Peel Adhesion	160 oz/in.
Cleavage Strength	20 psi
Dynamic Shear Strength	60 psi

**\*NOTE: For all UHB products, minimum 3" per item width or 10% surcharge will be added to roll price to recover material lost when slitting.**

### Physical Properties...

Density	62.5 lbs/ft <sup>3</sup>
Tensile Strength	200 psi
Elongation	500%
Peel Adhesion	240 oz/in.
Cleavage Strength	30 psi
Dynamic Shear Strength	90 psi

# Single Sided Low Density PVC Foam Tape...

## SF-VFLD... GRAY OR BLACK PVC Foam Tape

### Description...

A **low density** (between 6-10 lbs/ft<sup>3</sup>) closed cell PVC foam tape coated on one side with a high performance **acrylic** adhesive, and carried on a white siliconized paper liner. Good combination of flexibility & conformability with strength, wear & temperature resistance (remains pliable at -4°F to 176°F). Excellent weatherability and chemical resistance. It is a clean, waste free substitute for liquid sealants. An economical, general purpose foam tape. Used in applications requiring positive seals on irregular surfaces or when flexibility and conformability to seal tight radius curves are critical considerations.

### Applications...

Used extensively in the automotive, HVAC, and construction industries to provide air & weather tight seals; for gasketing, cushioning, vibration control in speakers, vehicles, electronic components, door frames, etc.

### Physical Properties...

Force to Compress 25% (range)	3.0-4.0 psi
Compression Deflection (range)	1.0-2.5 psi
Tensile Strength (Minimum)	>15 psi
Adhesion to SST (Minimum)	>12 oz/in

Alternative to Norton V700 series; Gaska #V710 and #V810; Novagard LD series.

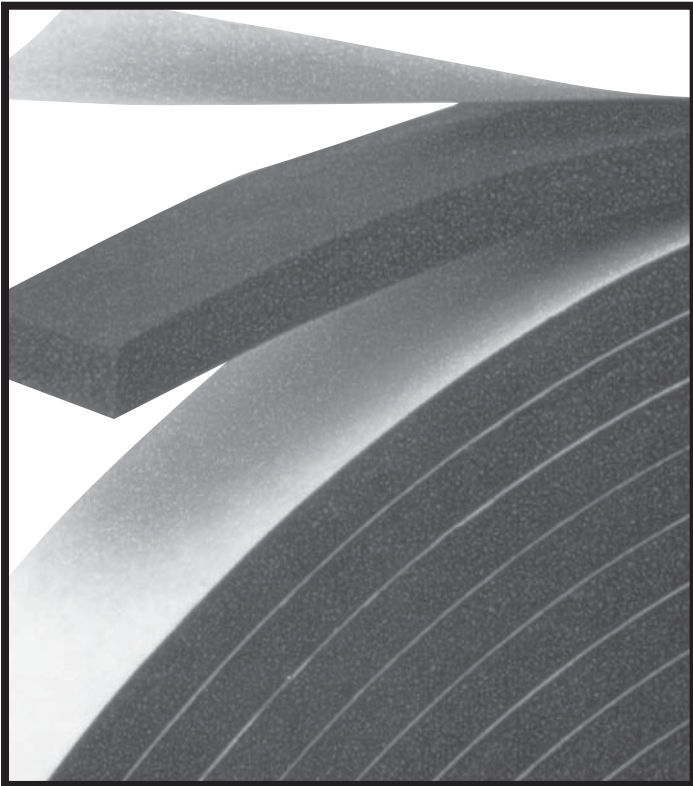

### 3/4" (0.75") THICK - 15 FT (BLACK ONLY)

3/4"	(18mm)	32
7/8"	(21mm)	27
1"	(24mm)	24
1.5"	(36mm)	16
2"	(48mm)	12
58"(54")*	(1372mm)	LOG

\* Usable width.

WIDTH	RLS/CS	CASES		
		1-2	3-5	6+

### 1/16" (0.063") THICK - 150 FT

3/16"	(4.7mm)	128
1/4"	(6mm)	96
3/8"	(9mm)	64
1/2"	(12mm)	48
5/8"	(15mm)	38
3/4"	(18mm)	32
7/8"	(21mm)	27
1"	(24mm)	24
1.5"	(36mm)	16
2"	(48mm)	12
56"(54")*	(1372mm)	LOG

### 1/8" (0.125") THICK - 75 FT

3/16"	(4.7mm)	128
1/4"	(6mm)	96
3/8"	(9mm)	64
1/2"	(12mm)	48
5/8"	(15mm)	38
3/4"	(18mm)	32
7/8"	(21mm)	27
1"	(24mm)	24
1.5"	(36mm)	16
2"	(48mm)	12
58"(54")*	(1372mm)	LOG

### 3/16" (0.188") THICK - 50 FT

1/4"	(6mm)	96
3/8"	(9mm)	64
1/2"	(12mm)	48
5/8"	(15mm)	38
3/4"	(18mm)	32
7/8"	(21mm)	27
1"	(24mm)	24
1.5"	(36mm)	16
2"	(48mm)	12
58"(54")*	(1372mm)	LOG

### 1/4" (0.25") THICK - 35 FT

1/4"	(6mm)	96
3/8"	(9mm)	64
1/2"	(12mm)	48
5/8"	(15mm)	38
3/4"	(18mm)	32
7/8"	(21mm)	27
1"	(24mm)	24
1.5"	(36mm)	16
2"	(48mm)	12
58"(54")*	(1372mm)	LOG

### 3/8" (0.375") THICK - 30 FT

3/8"	(9mm)	64
1/2"	(12mm)	48
5/8"	(15mm)	38
3/4"	(18mm)	32
7/8"	(21mm)	27
1"	(24mm)	24
1.5"	(36mm)	16
2"	(48mm)	12
58"(54")*	(1372mm)	LOG

### 1/2" (0.5") THICK - 25 FT

1/2"	(12mm)	48
5/8"	(15mm)	38
3/4"	(18mm)	32
7/8"	(21mm)	27
1"	(24mm)	24
1.5"	(36mm)	16
2"	(48mm)	12
58"(54")*	(1372mm)	LOG

# Single Sided Medium Density PVC Foam Tape...

## SF-VFMD... BLACK PVC Foam Tape

### Description...

A medium density (between 13-17 lbs/ft<sup>3</sup>) closed cell PVC foam tape coated on one side with a high performance **acrylic** adhesive. White siliconized paper liner. Higher density provides for a tougher more durable tape product for more demanding applications. Excellent combination of flexibility & conformability with strength, wear & temperature resistance (remains pliable at -4°F to 176°F). Excellent weatherability & chemical resistance. A clean, waste free substitute for liquid sealants.

### Applications...

Used extensively in the automotive, HVAC, and construction industries to provide air & weather tight seals; for gasketing, cushioning, vibration control in speakers, vehicles, electronic components, door frames, etc.

### Physical Properties...

Force to Compress 25% (Range)	6.5-9.5 psi
Compression Deflection (Range)	4.0-6.0 psi
Tensile Strength (Minimum)	>45 psi
Adhesion to SST (Minimum)	>12 oz/in

### 1/4" (0.25") THICK - 35 FT

1/4"	(6mm)	96
3/8"	(9mm)	64
1/2"	(12mm)	48
5/8"	(15mm)	38
3/4"	(18mm)	32
1"	(24mm)	24
1.5"	(36mm)	16
2"	(48mm)	12
58"(54")*	(1372mm)	LOG

WIDTH	RLS/CS	CASES		
		1-2	3-5	6+

### 1/16" (0.063") THICK - 150 FT

3/16"	(4.7mm)	128
1/4"	(6mm)	96
3/8"	(9mm)	64
1/2"	(12mm)	48
3/4"	(18mm)	32
1"	(24mm)	24
1.5"	(36mm)	16
2"	(48mm)	12
58"(54")*	(1372mm)	LOG

### 1/8" (0.125") THICK - 75 FT

1/4"	(6mm)	96
3/8"	(9mm)	64
1/2"	(12mm)	48
3/4"	(18mm)	32
1"	(24mm)	24
1.5"	(36mm)	16
2"	(48mm)	12
58"(54")*	(1372mm)	LOG

### 3/16" (0.188") THICK - 50 FT

1/4"	(6mm)	96
3/8"	(9mm)	64
1/2"	(12mm)	48
3/4"	(18mm)	32
1"	(24mm)	24
1.5"	(36mm)	16
2"	(48mm)	12
58"(54")*	(1372mm)	LOG

### \* Usable width.

Alternative to Norton #V760; Gaska #V1110 and #V1510; Novagard HD series.

# Window Glazing Tape: Double Coated PE Foam with Poly Liner...

## DC-PEF06P... 1/16" Foam Tape

## DC-PEF12P... 1/8" Foam Tape

High performance **closed cell cross-linked polyethylene foam** coated on both sides with a high performance **acrylic adhesive (2 mils per side)**. Designed for window glazing. Adhesive system is formulated to bond with glass, wood, and aluminum substrates with quick stick, high peel adhesion and very good shear strength. Outstanding resistance to weather for outdoor applications. Superior seal against dust and moisture due to flexible, soft foam. Easy peel **4 mil blue polypropylene release liner** for continuous & complete liner removal during window glazing applications. Other uses include mounting of emblems, nameplates, plastic strips, and mirrors. 3" neutral paper core/carton.

### Physical Properties:

	DC-PEF06P	DC-PEF12P
Thickness, Density	1/16" (62 mil), 4#	1/8" (124 mil), 2#
Peel Adhesion to SST (1 min)	55 oz/in	27 oz/in
Peel Adhesion to SST (24 hrs)	73 oz/in	46 oz/in
Shear Adhesion @ 1kg psi	168+ hours	
Service Temperature	-22°F to 212°F (short term up to 266°F)	

WIDTH	RLS/CS	CASES		
		1-2	3-5	6+

### 1/16" x 50 YD (150 FT) WHITE OR BLACK FOAM

1/4"	(6mm)	48
3/8"	(9mm)	32
1/2"	(12mm)	24
5/8"	(15mm)	20
3/4"	(18mm)	16
7/8"	(21mm)	14
1"	(24mm)	12
61"(59")*	(1500mm)	LOG

### 1/8" x 25 YD (75 FT) BLACK FOAM

1/4"	(6mm)	48
3/8"	(9mm)	32
1/2"	(12mm)	24
5/8"	(15mm)	20
3/4"	(18mm)	16
7/8"	(21mm)	14
1"	(24mm)	12
60"(59")*	(1500mm)	LOG

### \* Usable width.

Other roll widths available upon request.

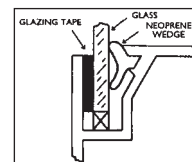

# Double Coated Polyethylene Foam Tapes...

**Closed cell, cross-linked polyethylene foam** tapes coated on both sides with a high performance **acrylic or rubber adhesive**. Tapes are permanent and designed to have exceptional durability in demanding environments. Suitable for applications where moisture resistance is required. Good resistance to humidity, mild acids, oil and grease. Excellent conformability and compressibility. Adheres well to textured and irregular surfaces. Can be easily die-cut. 3" neutral core/cartons.

**Applications...** Used for mounting nameplates, signs, small die cast parts, mirrors, maps, etc. Used for sound and vibration dampening in business machines, industrial equipment, electronic component packaging and glass panel mounts, seals, gaskets, etc. In general, the **acrylic adhesive** system is recommended for outdoor applications due to its higher temperature, UV, weather, chemical and plasticizer resistance. The **rubber adhesive** system is recommended for high shear demands as its quick grab nature is ideal for immediate load applications (mirrors) and for textured surfaces. The rubber system also exhibits higher adhesion to low-energy surfaces (some plastics, films).

**When ordering, specify: Foam Color (White or Black<sup>□</sup>) and Adhesive Type (Acrylic or Rubber)**

## DC-PEF03A... 1/32" Acrylic Based Adhesive

## DC-PEF03R... 1/32" Rubber Based Adhesive

### Physical Properties...

Foam	Cross-linked Polyethylene
Thickness, Density	1/32" (31 mils), 5#
Colors (2)	White or Black <sup>□</sup>
Adhesion (1 min, 24 hr dwell)	69 oz/in., 82 oz/in. (acrylic) 73 oz/in., 91 oz/in. (rubber)
Shear Adhesion @ 1kg psi	168+ hours
Release Liner	2.8 mil. 50# White Siliconized Paper

WIDTH	RLS/CS	CASES		
		1-2	3-5	6+
<b>72 YD (216 FT)</b>				
1/4"	(6mm)	48 or 96		
3/8"	(9mm)	32 or 64		
1/2"	(12mm)	24 or 48		
5/8"	(15mm)	20 or 40		
3/4"	(18mm)	16 or 32		
7/8"	(21mm)	14 or 28		
1"	(24mm)	12 or 24		
1.5"	(36mm)	8 or 16		
2"	(48mm)	6 or 12		
3"	(72mm)	4 or 8		
50"(48")*	(1220mm)	LOG		

<sup>□</sup> For double coated BLACK foam, ADD 5% (x1.05).

Alternative to Venture #632, #732; Scapa #SA432V, #SA5432V; IPG #8132; 3M #4482, #4462, #4492; Int'l Tape #332, #1328, #132, #432; Press-on P-3200R/A.

## DC-PEF06A... 1/16" Acrylic Based Adhesive

## DC-PEF06R... 1/16" Rubber Based Adhesive

### Physical Properties...

Foam	Cross-linked Polyethylene
Thickness, Density	1/16" (62 mils), 4#
Colors (2)	White or Black <sup>□</sup>
Adhesion (1 min, 24 hr dwell)	55 oz/in., 73 oz/in. (acrylic) 59 oz/in., 82 oz/in. (rubber)
Shear Adhesion @ 1kg psi	168+ hours
Release Liner	2.8 mil. 50# White Siliconized Paper

WIDTH	RLS/CS	CASES		
		1-2	3-5	6+
<b>36 YD (108 FT)</b>				
1/4"	(6mm)	48 or 96		
3/8"	(9mm)	32 or 64		
1/2"	(12mm)	24 or 48		
5/8"	(15mm)	20 or 40		
3/4"	(18mm)	16 or 32		
7/8"	(21mm)	14 or 28		
1"	(24mm)	12 or 24		
1.5"	(36mm)	8 or 16		
2"	(48mm)	6 or 12		
3"	(72mm)	4 or 8		
61"(59")*	(1500mm)	LOG		

<sup>□</sup> For double coated BLACK foam, ADD 5% (x1.05).

Alternative to Venture #617, #716; Scapa #SA416V, #SR516V; IPG # 8116; 3M #4446, #4496; Int'l Tape #316, #116, #116B, #416; Press-on P-3200R/A.

## DC-PEF12A... 1/8" Acrylic Based Adhesive

## DC-PEF12R... 1/8" Rubber Based Adhesive

### Physical Properties...

Foam	Cross-linked Polyethylene
Density	3 lbs/ft <sup>3</sup>
Thickness	1/8" (125 mils) 3.0mm
Color (1)	White
Adhesion (1 min, 24 hr dwell)	27 oz/in., 46 oz/in. (acrylic) 30 oz/in., 50 oz/in. (rubber)
Shear Adhesion @ 1kg psi	168+ hours
Release Liner	2.8 mil. 50# White Siliconized Paper

WIDTH	RLS/CS	CASES		
		1-2	3-5	6+
<b>18 YD (54 FT) WHITE</b>				
1/4"	(6mm)	48 or 96		
3/8"	(9mm)	32 or 64		
1/2"	(12mm)	24 or 48		
5/8"	(15mm)	20 or 40		
3/4"	(18mm)	16 or 32		
7/8"	(21mm)	14 or 28		
1"	(24mm)	12 or 24		
1.5"	(36mm)	8 or 16		
2"	(48mm)	6 or 12		
3"	(72mm)	4 or 8		
60"(59")*	(1500mm)	LOG		

Alternative to Venture #608, #708; Scapa #SR508V; Int'l Tape #308, #108; IPG #8108; Press-on P-3200R/A; Arlon #10C, #103.

Glazing foam tape, see page 59.  
Foam tape dispenser, see page 71.

\* Usable width.

# Permanent Transfer Tapes with Extended Liner...

## Permanent Hot Melt Rubber Transfer Tape...

A 1.0 mil (3.3 mil total) synthetic rubber adhesive with a 42# silicone coated paper liner with finger-lift edge. Provides a permanent surface-to-surface bond with strong initial tack. Will not bleed through lightweight materials and has high overall adhesion. Perfect for paper to paper attachments, signs & posters, envelope sealing & direct mail pieces. Also good for paper web splicing, labels & business forms, high speed presses & collaborators, as well as spot & strip tape applications. Adhesive Thickness: 1.0 mil. Liner Thickness: 2.3 mil. 180° Peel Adhesion: 105 oz/in. Loop Tack: 126 oz/in. Shear Strength (1000g): 48+hrs. Operating Temperature: 0°F to 140°F.

PERMANENT / PERMANENT					
STOCK	ROLL WIDTH	ADHESIVE WIDTH	LENGTH	RLS/CS	\$/ROLL
8502	1/2"	5/16"	3000'	10	
8503	3/4"	9/16"	3000'	7	
8504	1"	13/16"	3000'	5	
7323	3/4"	9/16"	4500'	7	

Note: Reverse wound (GSO) available. Specify "GSO" with item # when ordering.



# T-Tak™ Heavy Duty/Dispenser Pack...

## A versatile double coated tissue tape with extended liner

A 3.2 mil (5.7 mil total) synthetic rubber adhesive with exceptional holding strength and an aggressive adhesive system with a 42# coated paper liner with finger-lift edge. Superior performance on heavier weight papers and light board stocks. Works well on curved and uneven surfaces. Available with or without dispenser. Perfect for mounting heavy posters & signs, promotional displays, inventory tags on cartons, and mounting name plates. Good for permanent poly bag sealing, board envelope and box fabrication, business forms presses and collators, tag and label mounting, as well as packaging and box closure. Adhesive & Carrier Thickness: 3.2 mil. Liner Thickness: 2.5 mil. 180° Peel Adhesion: 90 oz/in. Loop Tack: 70 oz/in. Shear Strength (1000g): 48+ hrs. Operating Temperature: 20°F to 140°F.

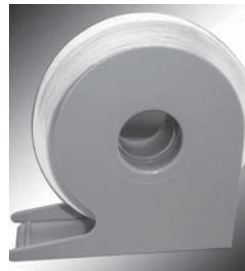

T-TAK™ HEAVY DUTY					
STOCK	ROLL WIDTH	ADHESIVE WIDTH	LENGTH	RLS/CS	\$/ROLL
7308	1/2"	1/4"	216'	48	
7309	3/4"	1/2"	216'	32	
7310	1"	3/4"	216'	24	
7312	3/4"	1/2"	1300'	7	
0321	1/2"	1/4"	2000'	10	
0322	3/4"	1/2"	2000'	7	
0317	1"	3/4"	2000'	5	

DISPENSER T-TAK™					
STOCK	ROLL WIDTH	ADHESIVE WIDTH	LENGTH	RLS/CS	\$/ROLL
8600	* 1/2"	1/4"	108'	12	
8601	* 3/4"	1/2"	108'	12	
8602	* 1"	3/4"	108'	12	

\*Provided in a convenient hand held dispenser.

# Permanent/Removable Extended Liner Tapes...

## HI/LO Permanent/Removable Polyester-Supported Tape...

A 2.8 mil (5.3 mil total) differential synthetic rubber with a polyester carrier and a 42# coated paper liner with finger-lift edge. Clear, lightweight adhesive for temporary bonding and repositioning on one side, permanent adhesive for long-term bonding on the other. Perfect for business forms, mailers & envelopes, labels and advertisements. Adhesive & PET Carrier Thickness: 2.8 mil. Liner Thickness: 2.5 mil. 180° Peel Adhesion: 50 oz/in (permanent side); 14 oz/in (removable side). Operating Temperature: 20°F to 140°F.

PERMANENT / REMOVABLE (HI / LO)					
STOCK	ROLL WIDTH	ADHESIVE WIDTH	LENGTH	RLS/CS	\$/ROLL
7211	1/2"	1/4"	1300'	10	
7212	3/4"	1/2"	1300'	7	
7216	1"	3/4"	1300'	5	

## Light Duty Regular Removable Transfer Tape...

A 1.0 mil (3.5 mil total) removable transfer tape with synthetic rubber based adhesive and a 42# coated Kraft paper with finger-lift edge. Clear, lightweight adhesive for temporary bonding with clean removable from a variety of surfaces. Good for lightweight attachments that require a short term bond. Business and hospital forms, mailers and envelopes, labels and advertisements. Adhesive Thickness: 1.0 mil. Liner Thickness: 2.5 mil. 180° Peel Adhesion: 2.1 oz/in. Loop Tack: 17.6 oz/in. Operating Temperature: 20°F to 150°F.

LIGHT DUTY REMOVABLE					
STOCK	ROLL WIDTH	ADHESIVE WIDTH	LENGTH	RLS/CS	\$/ROLL
7301	1/2"	5/16"	3000'	10	
7302	3/4"	1/2"	3000'	7	
7303	1"	3/4"	3000'	5	

Note: Reverse wound (GSO) available. Specify "GSO" with item # when ordering.

# Adhesive Transfer Tapes...

## TR-7502... Transfer

2.0 mil (0.050mm) Glass stabilized **modified acrylic adhesive** wound on a gold siliconized paper release liner. Glass stabilization allows for lathe slitting and cleaner unwinding. Moderate adhesion to most surfaces makes this a very economical choice for general purpose bonding/mounting applications. Extra wide web (59") makes tape suitable for laminating. **Peel Adhesion: 27 oz/in (1 min dwell); 37 oz/in (24 hr dwell)**. Temperature Range: -22°F to 230°F (284°F short term). 3" neutral core/carton.

59" (1500mm) x 800M Jumbos Available.

Alternative to Shurtape #TA-450; Tesa #4900, 3M #927; Berry Global #065; Achem #At15SA; Venture # 3802; Adchem #7332; Scapa #UP2020.

WIDTH	RLS/CS	CASES		
		1-2	3-11	12+
<b>60 YD (55M)</b>				
1/4"	(6mm)	144		
3/8"	(9mm)	96		
1/2"	(12mm)	72 or 96		
3/4"	(18mm)	48 or 64		
1"	(24mm)	36 or 48		
1.5"	(36mm)	24 or 32		
2"	(48mm)	18 or 24		
3"	(72mm)	12 or 16		
4"	(96mm)	12		
6"	(144mm)	8		
12"	(300mm)	4		
59"	(1500mm)	LOG		

<b>110 YD (100M)</b>				
1/2"	(12mm)	72		
3/4"	(18mm)	48		
1"	(24mm)	36		
1.5"	(36mm)	24		
2"	(48mm)	18		
3"	(72mm)	12		
4"	(96mm)	12		
59"	(1500mm)	LOG		

## TR-7502X... Transfer

2.0 mil (0.052mm) Glass stabilized **modified acrylic adhesive** wound on a gold siliconized paper release liner. Glass stabilization allows for lathe slitting and cleaner unwinding. More aggressive adhesive than TR-7502. Tape bonds well to most surfaces such as papers, films, metals, etc. Extra wide web (59") makes tape suitable for use as a laminating adhesive for foams or fabrics. **Peel Adhesion: 45 oz/in (1 min dwell); 55 oz/in (24 hr dwell)**. Temperature Range: -22°F to 230°F (284°F short term). 3" neutral core/carton.

59" (1500mm) x 800M Jumbos Available.

<b>60 YD (55M)</b>				
1/4"	(6mm)	144		
3/8"	(9mm)	96		
1/2"	(12mm)	72 or 96		
3/4"	(18mm)	48 or 64		
1"	(24mm)	36 or 48		
1.5"	(36mm)	24 or 32		
2"	(48mm)	18 or 24		
3"	(72mm)	12 or 16		
4"	(96mm)	12		
6"	(144mm)	8		
12"	(300mm)	4		
59"	(1500mm)	LOG		

Alternative to Scapa #U-263-1 & #UP2040; Shurtape #TA-450; Tesa #4900; 3M #927; Berry Global #065; Adchem #728.

## TR-7901... Transfer

2.0 mil (0.050mm). Glass stabilized **modified acrylic adhesive** wound on a brown siliconized paper release liner. Glass stabilization allows for lathe slitting and cleaner unwinding. High quick tack and good shear strength makes this the best choice for more demanding bonding/joining applications. Used for core starting, splicing of papers, films, metals and other webs. Can be used as a laminating adhesive for foams or fabrics. **Peel Adhesion: 50 oz/in (1 min dwell); 69 oz/in (24 hr dwell)**. Temperature Range: -22°F to 230°F (284°F short term). 3" neutral core/carton.

59" (1500mm) x 800M Jumbos Available.

<b>60 YD (55M)</b>				
1/4"	(6mm)	144		
3/8"	(9mm)	96		
1/2"	(12mm)	72 or 96		
3/4"	(18mm)	48 or 64		
1"	(24mm)	36 or 48		
1.5"	(36mm)	24		
2"	(48mm)	18 or 24		
3"	(72mm)	12 or 16		
4"	(96mm)	12		
6"	(144mm)	8		
12"	(300mm)	4		
59"	(1500mm)	LOG		

Alternative to IPG #8120; Permacel #593; Tesa #4985; Venture #3802; 3M #924; Scapa #U-263-1; Specialty Tape #D991.

## Custom Widths and Lengths Available for all "TR" Adhesive Transfer Tapes.

### 929TR... for tape up to 1" wide max.

Dispenser for transfer tapes on 3" core  
Maximum roll O.D. is 5-1/4" (cannot be used with 60yd TR-7505 or 110yd TR-7502, 7502X or 7901). Hand held dispenser for 2 mil transfer tapes on 3" cores. Acts like an ATG gun. Lays down tape with a trigger action. Winds up release liner for later disposal.



COST EACH	UNITS/CASE	CASE QTY
	6	/unit
		/case

# Adhesive Transfer Tapes...

## TR-7505... Transfer

4.7 mil (0.120mm) Glass stabilized **modified acrylic adhesive** with brown siliconized paper release liner. Glass stabilization allows for lathe slitting & cleaner unwinding. Thick adhesive coating coupled with high quick tack & good shear strength makes this the best choice for more demanding bonding/joining applications, especially for textured, rough surfaces. Used for core starting, splicing of papers, films, metals & other webs. Extra wide web (59") makes tape suitable as a laminating adhesive for foams or fabrics. **Peel Adhesion: 78 oz/in (1 min dwell); 105 oz/in (24 hr dwell)**. Temp. Range: -22°F to 230°F (284°F short term). 3" neutral core/carton.

59" (1500mm) x 500M Jumbos Available.

WIDTH	RLS/CS	CASES		
		1-2	3-11	12+
<b>60 YD (55M)</b>				
1/4"	(6mm)	144		
3/8"	(9mm)	96		
1/2"	(12mm)	72		
3/4"	(18mm)	48		
1"	(24mm)	36 or 48		
1.5"	(36mm)	24		
2"	(48mm)	18 or 24		
3"	(72mm)	12 or 16		
4"	(96mm)	12		
12"	(300mm)	4		
59"	(1500mm)	LOG		

Alternative to Scapa #U261; Shurtape #TA-499; Tesa #4988; 3M #468, #950; Achem #AT505A; Arclad #7335, #7511.

# Reverse Wound Adhesive Transfer Tapes...

## ATG-7501... Reverse Wound Transfer

Transfer tape. 1.6 mil (0.040mm). Glass stabilized acrylic adhesive. Gold paper liner. Good adhesion to paper, most plastic films, metal foils, etc. **Peel Adhesion: 24 oz/in (1 min dwell); 33 oz/in (24 hr dwell)**. Temperature Range: -22°F to 230°F (284°F short term). Reverse wound on 1" plastic core.

**ALL widths/lengths designed to fit in standard ATG dispensers.**

## ATG-7502... Reverse Wound Transfer

Transfer tape. 2.0 mil (0.050mm). Glass stabilized acrylic adhesive. Gold paper liner. Good adhesion to paper, most plastic films, metal foils, etc. For picture framing, product assembly, design & packaging prototypes. **Peel Adhesion: 27 oz/in (1 min dwell); 37 oz/in (24 hr dwell)**. Temperature Range: -22°F to 230°F (284°F short term). Reverse wound on 1" plastic core.

## ATG-7502X... Reverse Wound Transfer

Transfer tape. 2.0 mil (0.052mm). Glass stabilized acrylic adhesive. Gold paper liner. More aggressive than ATG-7502. Excellent adhesion to paper, most plastic films, metal foils. For picture framing, product assembly, design/packaging prototypes. **Peel Adhesion: 45 oz/in (1 min dwell); 55 oz/in (24 hr dwell)**. Temp. Range: -22°F to 230°F (284°F short term). 1" plastic core.

## ATG-7505... Reverse Wound Transfer

Transfer tape. 4.7 mil (0.120mm). Glass stabilized acrylic adhesive. Brown paper liner. High quick tack, good shear & holding power. Used for gap filling, mounting nameplates & trim-joining. Good bond to many irregular surfaces. **Peel Adhesion: 78 oz/in (1 min dwell); 105 oz/in (24 hr dwell)**. Temp. Range: -22°F to 230°F (284°F short term). 1" plastic core.



\*Fits ATG-50 or 3M dispenser without an adaptor!

WIDTH	RLS/CS	CASES		
		1-2	3-11	12+
<b>36 YD (33M)</b>				
1/4"	(6mm)	144		
1/2"	(12mm)	72		
3/4"	(19mm)	48		

WIDTH	RLS/CS	CASES		
		1-2	3-11	12+
<b>60 YD (55M)</b>				
1/4"	(6mm)	144		
1/2"	(12mm)	72		
3/4"	(19mm)	48		

WIDTH	RLS/CS	CASES		
		1-2	3-11	12+
<b>36 YD (33M)</b>				
1/4"	* (6mm)	144		
3/8"	* (9mm)	96		
1/2"	(12mm)	72		
3/4"	(19mm)	48		

Sub-packs: 1/4"=24 rolls; 3/8"=16 rolls; 1/2"=12 rolls; 3/4"=8 rolls  
Alternative to 3M #924, #987; Scapa #TD-200; Shurtape #TG-356;  
Tesa (NOPI) 7002-PV9.

\*Fits ATG-50 & standard ATG dispensers without an adaptor!

WIDTH	RLS/CS	CASES		
		1-2	3-11	12+
<b>36 YD (33M)</b>				
1/2"	(12mm)	72		
3/4"	(19mm)	48		

WIDTH	RLS/CS	CASES		
		1-2	3-11	12+
<b>60 YD (55M)</b>				
1/2"	(12mm)	72		

Sub-packs: 1/2"=12 rolls; 3/4"=8 rolls  
Alternative to 3M #976; Scapa #TD-200; Shurtape #TG-356;  
Tesa (NOPI) 7002-PV9.

WIDTH	RLS/CS	CASES		
		1-2	3-11	12+
<b>18 YD (16.5M)</b>				
1/4"	* (6mm)	144		
1/2"	(12mm)	72		
3/4"	(19mm)	48		

WIDTH	RLS/CS	CASES		
		1-2	3-11	12+
<b>36 YD (33M)</b>				
1/4"	(6mm)	144		
1/2"	(12mm)	72		
3/4"	(19mm)	48		

Sub-packs: 1/4"=24 rolls; 1/2"=12 rolls; 3/4"=8 rolls  
Alternative to 3M #926, #969; Scapa #TD-500; Tesa 425BPV5.

## ATG-50...

Tape dispenser for reverse wound transfer tapes on 1" plastic cores. Dispenser has a special pin spool allowing use of complete roll without any waste, friction or effort. It is also provided with an adjustable gear, just rotate spool to make it work. Weighs less than a lb. with tape!



COST EACH	UNITS/CASE	CASE QTY
	36	/unit
		/case

FITS ALL 36YD ATG TAPE (EXCEPT ATG-7505, ONLY FITS 18YD). ALSO, FITS 60YD ROLLS OF ATG-7501.

# Pressure Sensitive Envelopes...

Smaller envelopes are packed 1,000 per case; larger envelopes (designed to hold full sheets of paper) are packed 500 per case. Envelopes printed black and orange. Back loading design. NOTE: FIRST DIMENSION IS SLIT LOCATION.

**ENV-P4555S...** PACKING LIST ENCLOSED (1/4 FACE)  
O.D. Size: 4.5" x 5.5". End loading slit. 1,000 envelopes/case.

**ENV-P4555F...** PACKING LIST ENCLOSED (FULL FACE)  
O.D. Size: 4.5" x 5.5". End loading slit. 1,000 envelopes/case.

**ENV-I4555S...** INVOICE ENCLOSED (1/4 FACE)  
O.D. Size: 4.5" x 5.5". End loading slit. 1,000 envelopes/case.

**ENV-C4555...** CLEAR - NO IMPRINT  
O.D. Size: 4.5" x 5.5". End loading slit. 1,000 envelopes/case.

## COST PER CASE

1-4	5-9	10-24	25-49	50+
-----	-----	-------	-------	-----

## 4.5" x 5.5" ENVELOPES PACKED 1,000/CASE

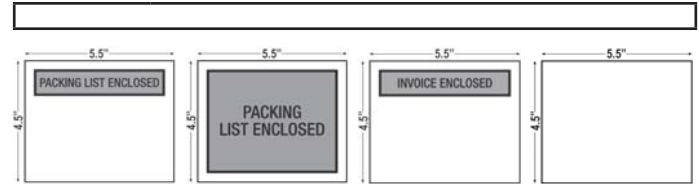

**ENV-P7555S...** PACKING LIST ENCLOSED (1/4 FACE)  
**Discontinued.** Available as special order.

**ENV-C7555...** CLEAR - NO IMPRINT  
O.D. Size: 7.5" x 5.5". Top loading slit. 1,000 envelopes/case.

## 7.5" x 5.5" ENVELOPES PACKED 1,000/CASE

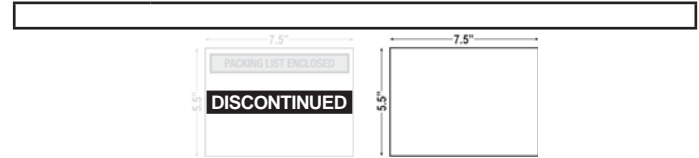

**ENV-P55100E...** PACKING LIST ENCLOSED (1/4 FACE)  
O.D. Size: 5.5" x 10". End loading slit. 1,000 envelopes/case.

**ENV-C55100E...** CLEAR - NO IMPRINT  
**Discontinued.** Available as special order.

## 5.5" x 10" ENVELOPES PACKED 1,000/CASE

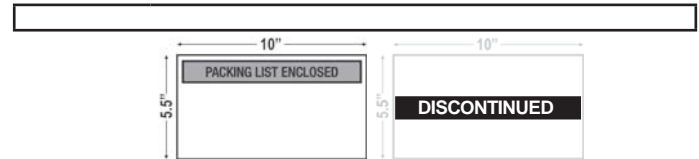

**ENV-C9512...** CLEAR - NO IMPRINT  
O.D. Size: 9.5" x 12". End loading slit. For holding 8.5" x 11" paper. 500 envelopes/case.

## 9.5" x 12" ENVELOPES PACKED 500/CASE

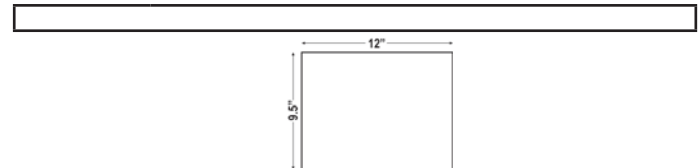

**ENV-C1012NP...** CLEAR - NO IMPRINT  
O.D. Size: 10" x 12". End loading slit. For holding 9" x 11" paper. 500 envelopes/case.

## 10" x 12" ENVELOPES PACKED 500/CASE

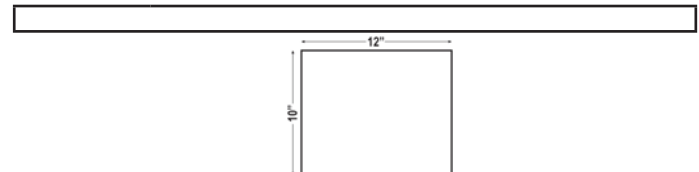

# Pouch Tapes...

2 mil clear polypropylene film with an orange ink border printed with "DOCUMENTS ENCLOSED". The film is coated with an acrylic adhesive only along the edges. The adhesive-free center creates a see-through pouch when applied to a surface. Linerless & easy to use - just peel & stick. Peel Adhesion: 32 oz/in.

**DE5x6...**  
O.D. Size: 5" x 6"; I.D. Pouch Size: 3 1/4" x 4 1/2". 500 pouches per roll, 8 rolls per case.

**DE6x8...**  
O.D. Size: 6" x 8"; I.D. Pouch Size: 4 1/2" x 6 1/2". 500 pouches per roll, 8 rolls per case.

## CASES (COST PER ROLL)

ITEM	RLS/CS	CASES (COST PER ROLL)			
		1-2	3-6	7-15	16+
DE 5x6	8				
DE 6x8	8				

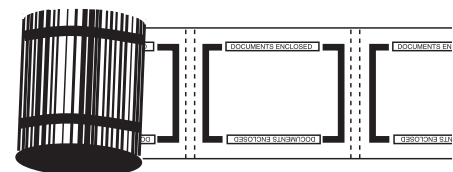



# Retail Dispensers with Tape...

## 20HT-D...

**Stationery tape on 1/2 dispenser.**

Retail put-up. 1/2" and 3/4" wide x 800" roll of OPP stationery tape on a half-sided dispenser with plastic blade. 6 inner cartons per box. Carded (generic imprint).

COST EACH	UNITS/CASE	CASE QTY
N/A	144	
	1/2" x 800"	/case
N/A	96	
	3/4" x 800"	/case



## EX-243L...

**Crystal clear tape with dispenser.**

Retail put-up. 2" x 800" roll of 2 mil crystal clear tape on a 1.5" core with a plastic, hand-saver dispenser. Carded (generic imprint).

N/A	48	/sub-pack
N/A	144	/case



# Hand Held Tape Dispensers...

## ET-166...

**Filament/strapping tape dispenser.** For tape up to 1" wide. Maximum roll diameter of 5 1/2". 3" core.

COST EACH	UNITS/CASE	CASE QTY
	100	/case



## ET-218...

**Plastic carton sealing tape dispenser for 2" tape.** Static cling strip and retainers to ensure tape is always in the ready-to-use position. Retractable Safety Blade Cover. Packed individually in a colorful retail box.

**DISCONTINUED / SOLD OUT**



## ET-226...

**Filament/strapping tape dispenser; also used for carton sealing tapes.** For tape up to 2" wide. Maximum roll diameter of 5-1/2". Metal frame. 3" core.

	60	/case
--	----	-------



## ET-0050...

**Heavy duty carton sealing tape dispenser; also used for filament/strapping tapes.** All metal construction with built-in internal hand brake for tension control. For tape up to 2" wide. Maximum roll diameter of 4 3/4". Includes extra blade. 3" core.

	24	/case
--	----	-------



## ET-366...

**Carton sealing tape dispenser; also used for filament/strapping tapes.** For tape up to 3" wide. Maximum roll diameter of 5 1/2". Metal frame with safety blade cover. 3" core.

	32	/case
--	----	-------



**Note:** Please inquire for pricing and availability on dispenser replacement parts.

# Carton Sealing Hand Held Tape Dispensers...

## LN-285... Silent Gun

For tape up to 2" wide. Maximum roll diameter of 5". Carton sealing tape dispenser. Side loader. 3" core.

**DISCONTINUED / SOLD OUT**



## EC-233...

For tape up to 2" wide. Maximum roll diameter of 5". Metal frame carton sealing tape dispenser. Side loader with adjustable brake. 3" core. Side loader with adjustable brake. New rubber roller to prevent static cling. Packed individually in a colorful retail box. 3" core.

COST EACH	UNITS/CASE	CASE QTY
	40	/case



## SNC-289N... Low Noise

2" Mousetrap dispenser with blade cover. Rubber roller with static cling strip. U.S. Pat. No. 6641081.

	24	/case
--	----	-------



## EC-209...

For tape up to 2" wide. Maximum roll diameter of 5 1/2". Metal frame carton sealing tape dispenser. Side loader with adjustable brake. 3" core.

	40	/case
--	----	-------



## EC-238... Heavy Duty

For tape up to 2" wide. Maximum roll diameter of 5 1/2". Heavy-duty metal frame carton sealing tape dispenser. Natural rubber roller to create static to keep tape in ready-to-use position. Side loader with adjustable brake. 3" core.

	30	/case
--	----	-------



**Note:** Please inquire for pricing and availability on dispenser replacement parts.

# Carton Sealing Hand Held Tape Dispensers...

## EC-326...

For tape up to 3" wide. Maximum roll diameter of 5". Metal frame carton sealing tape dispenser. 3" core. **Side loader with adjustable brake.**

COST EACH	UNITS/CASE	CASE QTY
	24	
		/case



## SNC-389... Low Noise

3" Mousetrap dispenser with blade cover. Natural rubber roller to create static to keep tape in ready-to-use position and static cling strip.

	24	
		/case



## EC-306...

For tape up to 3" wide. Maximum roll diameter of 6". Metal frame carton sealing tape dispenser. 3" core. **Side loader with adjustable brake.**

	12	
		/case



## EC-338... Heavy Duty

For tape up to 3" wide. Maximum roll diameter of 5 1/2". Heavy-duty metal frame carton sealing tape dispenser. Natural rubber roller to create static to keep tape in ready-to-use position. 3" core. **Side loader with adjustable brake.**

	20	
		/case



## EC-401... Heavy Duty

For tape up to 4" wide. Maximum roll diameter of 5 3/4". Carton sealing & label protection tape dispenser. 3" core. **Metal Frame Top loader without brake.**

	10	
		/case



## EC-438... Commercial Grade

For tape up to 4" wide. Maximum roll diameter of 5 3/4". This **commercial grade**, cantilever designed dispenser has a special hardened steel-tooth blade, soft rubber roller, ABS resin handle, and a **heavy-gauge stamped-steel frame** for extra rigidity. 3" core. **Side-loading with an adjustable brake.**

	5	
		/case



**Note:** Please inquire for pricing and availability on replacement parts for hand held tape dispensers.

# Walk Along Tape Dispenser...

**2LM...** For lane marking tape up to 4" wide

**Aisle/lane marking tape dispenser.** 3" core. Individually cartoned. NOT RETURNABLE.

For vinyl aisle marking tapes, see pages 8-11. For cloth duct tape, see page 3.

COST EACH	UNITS/CASE	CASE QTY
	10	
		/case
N/A	50	
		/crate

Replacement Parts:  
DP-002LMSAS Spool Axle Set

B-2LM000000 Cartons K.D. for above  
/each ( for pack of 50)



# Stretch Film Dispensers & Accessories...

## SD-259B... Stretch film/strapping cutter

Specially angled cutter head safely glides through stretch film without bunching/sticking, and without cutting merchandise or user.

COST EACH	UNITS/CASE	CASE QTY
N/A	12	/sub-pack
N/A	720	/case

Case of 720 has 60 sub-packs of 12 cutters.  
Blue color.



## SF-750...

Plastic handwrap handle for 3" (75mm) core.

/ea.	100	/case
------	-----	-------



## SF-755... (Priced & Sold by Pair)

For film up to any width. **Handy-cup stretch film core holder/dispenser** with improved ergonomic design to reduce hand-fatigue. Excellent premium/promotional item. 3" core.

/pr.	75	/pr.
		/case



## SF-773... (Priced & Sold by Pair)

For film up to any width. **Deluxe handy-cup stretch film core holder/dispenser** with **adjustable brake** to help control film tension. Lightweight, ergonomic design. 3" core.

/pr.	40	/pr.
		/case



## SF-2781A...

For film up to 18" wide. **Stretch film dispenser. Aluminum base.** Adjustable to 12", 15" and 18" widths. Fits 1.5", 2" and 3" cores.

	6	/case
--	---	-------

Replacement Parts:  
127824 Aluminum Spool



# Tabletop Tape Dispensers...

## **NEW** ET-12281...

For tape up to 2" wide. Maximum roll diameter of 5.5". **Twin-roll bench top dispenser with C-clamp.** C-clamp quickly attaches to a bench/table (no screws required). Holds single roll up to 2" wide; or 2 rolls, each up to 1" wide. 3" core. Wide 2.75" blade with safety cover.

COST EACH	UNITS/CASE	CASE QTY
	24	/case



# Tabletop Tape Dispensers...

## ET-133...

For tape up to 3/4" wide. Maximum roll diameter of 2.5". **Twin core desktop dispenser.** Holds 2 rolls of stationary tape on 1" cores. Non-slip weighted base for stability.

**DISCONTINUED / SOLD OUT**

/case



## EX-191BK...

For tape up to 1" wide. Maximum roll diameter of 5". Desktop dispenser with 1" and 3" cores. Lowest cost desk dispenser.

Replacement Parts:  
219103 3" Plastic Core  
219104 1" Plastic Core

COST EACH	UNITS/CASE	CASE QTY
	6	

/case



## **NEW** ET-11171...

For tape up to 1" wide. Maximum roll diameter of 5". High quality, **steel desktop dispenser.** Holds single roll up to 1" wide. 3" core. Extra wide, anti-rust stainless steel blade with safety cover. Weighted rubber lined base for stability.

Replaces ET-117.

10
----

/case



## **NEW** ET-12270...

For tape up to 2" wide. Maximum roll diameter of 5". **Twin-roll steel desktop dispenser.** Holds single roll up to 2" wide; or 2 rolls, each up to 1" wide. 3" core. Extra wide, anti-rust stainless steel blade with safety cover. Weighted rubber lined base for stability.

Replaces ET-227.

10
----

/case



## **NEW** ET-13370...

For tape up to 3" wide. Maximum roll diameter of 5". **Multi-roll steel desktop dispenser.** Holds single roll up to 3" wide; 2 or 3 rolls, each up to 1" wide. 3" core. Extra wide, anti-rust stainless steel blade with safety cover. Weighted rubber lined base for stability.

Replaces ET-337.

6
---

/case



## **NEW** MD/4RB... with Razor Blades MD/4TB... with Toothed Blades

Holds 4 rolls of tape, each up to 1" wide. Maximum roll diameter of 5" (on two rollers) and 6" (remaining two rollers). **Heavy-duty, quadruple-roll steel desktop dispensers.** Fast access to a variety of tapes (single-sided and double coated). Each core holder functions independently. 3" cores. Weighted-rubber lined base for stability.

### Typical Uses:

**MD/4RB (Razor Blade)** - Primarily designed for thin films (OPP, PVC, etc.) where a precise, straight cut is required. Ideal for graphic design field, production dept., etc.

**TD/4RB (Toothed Blade)** - Used for a wider variety of tapes, including filament tapes, paper tapes, OPP & PVC films, as well as some double coated tapes.

Replacement Parts:  
MD9220002 Razor Blade (25mm)  
MD9220004 Razor Blade Protector  
MD9220005 Razor Blade Holder  
MD9210002 Toothed Blade (25mm)  
MD9210004 Toothed Blade Protector

**Specify MD/4RB or MD/4TB when ordering.**

6
---

/case



Front  
(in use)



Back

# Produce/Bag Seal Tape Dispensers...

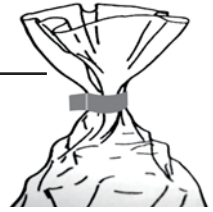

## Instructions for Bag Seal Tape Dispensers

1. Insert dispenser core into tape core, and slip into dispenser's core holder.
2. Pull tape over the top of dispenser, making sure that the adhesive side is facing UP.
3. Twist bag and pull down, through dispenser.
4. Use blade on bottom to trim bag.

See page 26 for Bag Sealing Tape.



**EX-909K...** For tape up to 9mm wide **EZ open bag sealer with trimmer.** Will hold a roll of paper (3/4" core) along with roll of 3/8" wide PVC tape (3" core) so that seal can be easily broken (tape adheres to strip of paper instead of to itself at "tail" end of tape for easy tear). Functions the same as above bag sealers, but offers the option of **use with a roll of paper or without.**



\*Special interim price due to internal part changes.

### Replacement Sets/Parts:

- 605GST Gear Set
  - Gear, Spacer Axle
- 605BHS Inside Blade Set
  - Blade, Blade Holder, Blade Screw, Spacer Axle, Spring
- 605016 Trimmer Blade
- 605023 Screw
- 210324 Inside Screw

COST EACH	UNITS/CASE	CASE QTY
	10	

/case

**ET-605K...** For tape up to 12mm wide **Produce tape dispenser/bag sealer with trimmer.** Baked enamel finish. 3" core.

	10	
--	----	--

/case



### Replacement Sets/Parts:

- For both ET-605K & ET-606STK

- 605CST Core Set
  - Core, Friction Washer
- 605GST Gear Set
  - Gear, Spacer Axle
- 605PSS Pressure Slide Set
  - Pressure Slide, Spring, Spacer Axle
- 605SLS Stop Lever Set
  - Stop Lever, Spring, Spacer Axle
- 605BHS Inside Blade Set
  - Blade, Blade Holder, Blade Screw, Spacer Axle, Spring
- 605016 Trimmer Blade
- 605003R Spacer Axle
- 605021R Screw

**ET-606STK...** For tape up to 12mm wide **Produce tape dispenser/bag sealer with trimmer.** Stainless steel. 3" core.

	10	
--	----	--

/case



**ET-808K...** For tape up to 16mm wide **Produce tape dispenser/bag sealer with trimmer.** Wide neck to handle thicker bags. Baked enamel finish. 3" core.

	10	
--	----	--

/case



### Replacement Sets/Parts:

- 808BHS Inside Blade Set \$2.70\*
  - Blade, Blade Holder, Blade Screw, Spring
- 808004 Tape Core
- 605016 Trimmer Blade
- 808003 Gear

**NEW** **ET-635...** For tape up to 25.4mm wide **Produce tape dispenser/bag sealer/wrapper/bundler w/ safety lock.** Heavy-duty steel with non-slip pad for stability. **Exposed wrapping platform (good for thick bags/wide objects).** Used for bag sealing (narrow to wide neck widths), wrapping produce, and bundling wires/cables/supplies. Spring-loaded toothed blade for easy wrapping & cutting. **Fits 1", 3" and 3.5" cores.**

	10	
--	----	--

/case



### Unique tri-core:



# Transfer & Double Coated Tape Dispensers...

**ATG-50...** For **reverse wound transfer** tape up to 1" wide  
Tape dispenser for reverse wound transfer tapes on 1" plastic cores. Dispenser has a special pin spool allowing use of complete roll without any waste, friction or effort. It is also provided with an adjustable gear, just rotate spool to make it work. Weighs less than a lb. with tape! Fits all 36yd ATG tape (except ATG-7505, only fits 18yd). Also, 60yd rolls of ATG-7501.

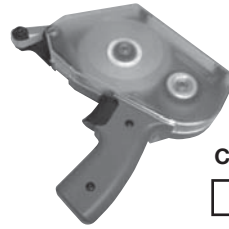

COST EACH	UNITS/CASE	CASE QTY
	36	/case

**929TR...** For **transfer** tape up to 1" wide max.  
Dispenser for transfer tapes on 3" core Maximum roll O.D. is 5-1/4" (cannot be used with 60yd TR-7505 or 110yd TR7502, 7502X or 7901). Hand held dispenser for 2 mil transfer tapes on 3" cores. Acts like an ATG gun. Lays down tape with a trigger action. Winds up release liner for later disposal.



	6	/case
--	---	-------

**925DC-1...** For **double coated** tape up to 1" wide, 1" & 3" cores. **Double coated hand held tape dispenser.** Applies tape to working surfaces while rewinding the liner on the take-up spool. Heavy formed steel frame for long life. Adjustable tension brakes on tape roll holder and scrap rewind spool insure proper performance with any weight tape. Ideal for longer length lay-down applications. Consider our 926DC-2 for shorter length applications. Not recommended for thick, difficult to cut tapes. Holds rolls up to 1" wide with maximum 5-1/2" diameter. 1" & 3" cores.



	6	/case
--	---	-------

**925DC-2...** For **double coated** tape up to 2" wide  
**Double coated hand held tape dispenser.** Applies tape to working surfaces while rewinding the liner on the take-up spool. Heavy formed steel frame for long life. Adjustable tension brakes on tape roll holder and scrap rewind spool insure proper performance with any weight tape. Ideal for longer length lay-down applications. Consider our 926DC-2 for shorter length applications. Not recommended for thick, difficult to cut tapes. Holds rolls up to 2" wide with maximum 5-1/2" diameter on 3" core.



	5	/case
--	---	-------

Replacement Part:  
#DP-09355012 Blade (each)

**926DC...** For **double coated** tape up to 2" wide  
**Tabletop double coated tape dispenser.** Dispenses double sided tape or other tapes with removable liner. One easy pull releases tape and peels off backing, rewinding it on the take-up spool. Tape roll holder and scrap rewind spool have independent adjustable brakes to insure proper performance with any weight tape. Clean cutting tempered steel blade is easily replaced. Holds rolls up to 2" wide with max OD of 7.1" (180mm). 3" core. Size: 3" W x 12" L.



	5	/case
--	---	-------

**950F...** Tabletop for **foam** tape up to 2" wide  
**Foam tape tabletop dispenser.** Dispenses foam tapes with a max OD of 14.5" (370mm) while removing liner onto a spool. Peeled tape is ready to use and cut with scissor blades. Sliding arm allows for cutting preset lengths up to 500mm. Powder coated steel construction. 3" core and spool have adjustable brakes.



	1
--	---

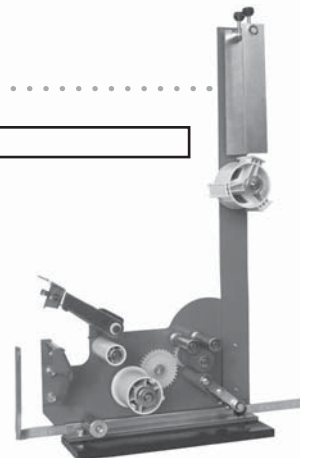

# Hand Held Label Applicator...

## NV030...

Ideal for repetitive labeling of boxes or bags. Simply squeeze the handle to dispense and apply any die-cut label. **Maximum label width 1.20" (30mm)**. Maximum label length 2.36" (60mm). Minimum core size 1" (25.4mm). Maximum outside diameter of roll 3.93" (100mm). No custom tooled slots needed to dispense labels, just a 1/8" (3.2mm) gap between labels. Heavy-duty, made for industrial use. Unique sensor automatically adjusts the label stroke. Patented mechanism dispenses virtually any shape of die cut label.

COST EACH



# Definite Length Tape Dispensers...

Both CM0300 and CM0800 WT dispensers are recommended for BOPP, polyesters to 3.5 mil, and some flatback tapes. Not suitable for thick films, stretchy films (vinyls), or foil tapes.

## CM0300...

For single sided tapes up to 1" wide. Manual feed pressure sensitive tape dispenser with hand lever. **Definite length dispenser**. Dispenses tape from: Width of 1/4" to 1", and 1/2" to 4" length with a single pull. Tape is cut by pulling across a serrated blade. Moveable blade holder for easy tape loading. Heavy base for stability. Maximum roll O.D. is 4-3/4". Holds 3" core tapes.

COST EACH    UNITS/CASE    CASE QTY

Replacement Parts:  
CM0300P101

Blade

	12	
--	----	--

/case



## CM0800WT...For single sided tapes up to 1" wide.

Automatic low cost tape dispenser. Dispenses tape from: Width of 1/4" to 1" and automatically advances tape to 3-fixed lengths of 1.18", 1.77" and 3.54". Tape is cut by raising and pulling across a serrated blade which activates a switch to advance the next piece of tape. Maximum roll O.D. is 5-1/4". comes with 1" and 3" cores. Battery operated or electronic.

**CM0800WT comes with AC adapter.**

Replacement Parts:  
CM0800P140

Blade

	10	
--	----	--

/case



## M1000... For PSA tape up to 2" wide

**Electronic tape dispenser** ideal for medium production facilities. Automatically advances and cuts tape with digital length adjustment. **Dispenses tape .28" to 2" wide. Cuts tape length range: .79" to 39"**. Adjustable pressure feed to help prevent curling of tape. Manual override of preset lengths. Photocell actuated feed mechanism & cutter or manual feed & cut. 3" core.

Call for options:

Footswitch  
Small Reel Stand  
Creaser

	6	
--	---	--

/case



## DA080...for PSA tape up to 3.15" wide

**Electronic "Heavy Duty" tape dispenser**. Automatically dispenses and cuts virtually any tape - including duct tape. Designed for continuous industrial use. Compact design & heavy duty metal construction. **Accepts tape widths from .375" to 3.15". Cuts lengths from 2" to 394"**. 9" max. outside diameter roll. 3" core. Adjustable feed intervals. Can be modified to dispense non-adhesive materials. Safety interlock. **CONTINUOUS INDUSTRIAL USE.**

Replacement Parts:  
DA080P279  
DA080P279S

Razor Blade  
Serrated Blade

	4	
--	---	--

/case

Call for options:

Large Reel Stand





# Gum (Water Activated) Tape Dispensers...

## HAND TAPER... with or without heater

Economical. Model TDH110 with heater: constant hot water and steady flow through brush activates glue quickly & evenly. Up to 9" roll dia. Weight: 30 lbs.

TWA1000M	Manual Taper	-
TDH	Without Heater	-
TDH110	With Heater	-

**DISCONTINUED / SOLD OUT**

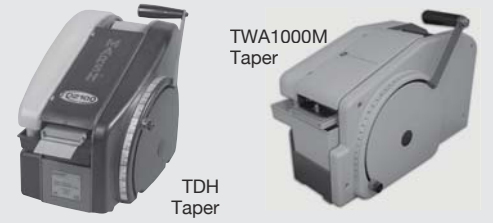

# Water Activated Paper Tape...

## WAT-WAE... Reinforced up to 25 lbs.

Light Duty Reinforced Water Activated Tape. Laminated with non-asphaltic adhesive. Top Sheet 23 lbs/ream Natural Virgin Kraft / Bottom 23 lbs. 3-way Reinforcing Pattern: Lengthwise is 110 Denier Fiberglass - 5/8" spacing (1-1-1-1-1); Cross Machine is 150 Denier Fiberglass / Diamond Pattern <1.25". Recommended for sealing light weight cartons weighing up to 25 lbs.

See page 19 for Custom Printed Water Activated Gummed Tape

WIDTH x LENGTH	RLS/CS	COST/ROLL
3" (70mm) x 450'	10	Email/Call
3" (70mm) x 500'	6	for Pricing

Pallet quantities only.

Alternative to IPG #233, #53811, #K8069; Crowel #R2N3L



# Converter Accessories...

## Siliconized Paper Release Separators...

Packed 10,000 sheets per case		COST/CASE
RS6X3D	6" O.D. CIRCLE (3" I.D. HOLE)	

Packed 2,500 sheets per case		
RSH95X95PE	9.5" x 9.5"	PE Coated for UHB High Bond Tapes
RSH12X12PE	12" x 12"	PE Coated for UHB High Bond Tapes

Packed 2,500 sheets per case		COST/CASE
RS9.5X9.5	9.5" x 9.5"	
RS9.5X12	9.5" x 12"	
RS9.5X12.5	9.5" x 12.5"	
RS14.5X10	14.5" x 10"	
RS10.5X16	10.5" x 16"	
RS10.75X16	10.75" x 16"	
RS11X11	11" x 11"	
RS11.5X11.5	11.5" x 11.5"	
RS11X17	11" x 17"	
RS12X12	12" x 12"	
RS13.5X19	13.5" x 19"	
RS13.75X19	13.75" x 19"	
RS14X11	14" x 11"	
RS14X14	14" x 14"	
RS14.5X975	14.5" x 9.75"	
RS14.5X10	14.5" x 10"	
RS17X11	17" x 11"	

## Steel Replacement Blades... M-2 Tool Steel

(Call for more detail)

8.07" O.D. x .100" Thick x 1" ID
22" O.D. x .190" Thick x 1" ID

## Mold-Lube Lubricant...

Siltex Mold-Lube

5 gallon
55 gallon

## PE Plastic Mandrel Sleeve Covers...

1" (19mm I.D.) x 25.4mm O.D. x 53" prox.
1.5" (31.7mm I.D.) x 38.1mm O.D. x 65" prox.
3" (69mm I.D.) x 76.2mm O.D. x 65" prox.

## 4863RW... Mandrel Dimpled Roller Wrap

31.5 mil. Gray embossed fabric with silicone rubber coating. Acrylic Adhesive. Provides "non-slip" effect. Used in adhesive tape manufacturing, general converting, printing, textiles, and paper/film industries. Adhesion to Steel: 48 oz/in. Temperature: Up to 176°F. PP liner. 3" neutral core.

WIDTH x LENGTH	RLS/CS	ROLL	CASE
2" (50mm) x 25M	2		

Alternative to Tesa #4863.



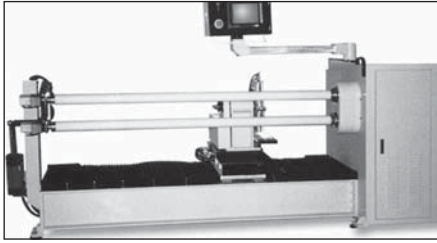

**SLITTER...** MODEL: LS-192

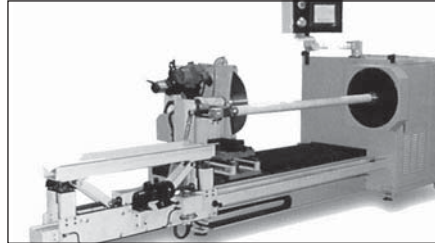

**FOAM SLITTER...** MODEL: LS-451

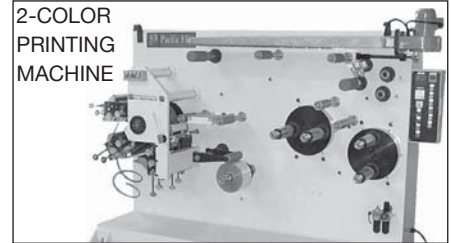

**2-CLR TAPE PRINTER...** MODEL: FP-304-2



**REWINDER...** MODEL: R-161

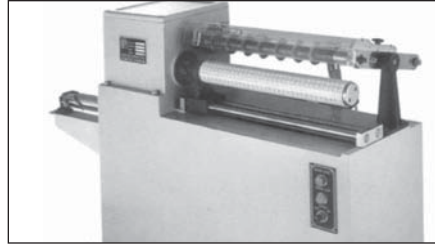

**CORE CUTTER...** MODEL: C-101



**LOGGER...** MODEL: R-301

**New and used converting equipment available!**

---

---

**Notes:**

PRODUCT DESCRIPTION	PAGE
Aisle Marking Tapes & Dispenser	8-11
Aluminum Foil Tapes	36-38
Appliance Tapes	28
Application Tapes	17
ATG Tapes	63
Bag Sealing Tapes (UPVC)	26
Barricade Tapes	7
Bookbinding Tape	2,25
CablZone Tapes	4
Camouflage Tape	4
Carpet Tapes (Double Coated)	48,52
Carton Sealing Tapes	16-26,29
Cellophane Tapes	26
Circuit Board Tapes	40-41
Conspicuity Tapes	32-34
Converter Accessories	73
Copper Foil Tapes	39
Custom Printed Tapes	17,19
Differential Adhesive Tapes, Double Coated	48,61
Dispensers & Replacement Parts	65-73
Double Coated Tapes	45-57,59-61
Dry Vinyl Tapes	11
Duct Tapes	3-5
Electrical Tapes	6
Electroplating Tapes	10,12-13,36-39,42
Extended Liner Tapes	61
Filament Tapes	29
Flatback Paper Tapes	16,49
Fluorescent Tapes	5,14,25,34
Foam Tapes	54-60
Foil Tapes	36-39
Friction Tapes	5
Gaffers Tapes	2,4
Glass Cloth Tapes	42-43
Glazing Tape	59
"Glow in the Dark" Photoluminescent	14,35
Graphic Arts Tapes	17,44,63
Gummed Paper Tapes	19,73
Hazard Identification Tapes	4,10-11,14
High Bond Tapes	54-57
High Temperature Masking Tape	15,40-43
Hook & Loop	27
Invisible Mending Tape	27
Kraft Paper Tape	16,73
Label Protection/Lamination Tapes	26-27
Lead Foil Tapes	39
Magnetic Tapes	31
Masking Tapes	15-17,40-43
Mending Tapes	27
Mylar Polyesters	40-41,44
Office Supply Tapes	27
Packing List Envelopes	64
Photoluminescent ("Glow in the Dark") Tapes	35
Pipe Thread Seal Tapes (Teflon™/PTFE)	12
Pipe Wrap Tapes	7-9,12
Polyester Film Tapes	24,40-41,44
Polyethylene Film Tapes (LDPE/UHMW)	12-13,44
Polyimide Tapes	43
Pouch Tapes	64
Premask Tapes	17
Printed Carton Sealing Tapes	17-19
Printers' Rolls (UPVC & BOPP)	30
Produce Tapes (UPVC)	26
PVC Bag & Carton Sealing Tapes	25-26
Reflective/Retroreflective Tapes	32-34
Safety Tapes	4-5,7,10-11,14,32-35
Security Tapes	17-18
Silicone Splicing Tapes	40-41
Skid Resistant Tapes	14
Skived Teflon™ (PTFE) Tapes	42
Splicing Tapes	40-41
Stationery Tapes	27
Strapping Tapes	28
Stretch Film - Hand Wrap	30
Striped Safety Tapes	4,7,10-11,14,32-33
Tamper Evident Tapes	17
Teflon™ - Glass Fabric, Skived, & Pipe Thread Seal Tapes	12,42-43
Transfer Tapes	57,61-63
Velcro®	27
Vinyl Tapes (SPVC)	6-11
Water Activated Paper Tapes	19,72

ITEM NUMBER	PAGE
4863RW	5
AF-12A/R,-16A/R,-20A/R/SW,-20A-B,-22A-B,-30A/SW,-50A,-FSK-A/R	36-38
AT-UHB10,-UHB40,-UHB60	57
ATG-50 (dispenser)	71
ATG-7501,-7502,-7502X,-7505	63
BRC	7
CDT-EG7,-UG7,-36,-70,-70HD,-70F,-80CAM,-HS	3-5
CELLO	26
CFB-60,CFB-75	16
CFL-5A,CFL-5CA	39
CFT-15	5
CGT-80,-80F,-80MG,-665C	2,5
CPM-60	15
CUSTOM PRINTED TAPES	19
CVT-536,-560,-636,-636P,-660,-660P,-A,-D	8-9
CZT-70B,-70B/Y,-80LBG,-140MB	4
DC-1114,-4106LW,-4109RS/CS/R,-4123 (Polyester)	46-47
DC-1210,-3208SA,-3212SA,-4210RS,-4210VS-B,-4215WO (Tissue)	50-51
DC-1503,-1511,-3522 (Polypropylene)	47
DC-2306,-2307,-2308,-2315,-4309LW,-4317VS (Paper)	48-49
DC-3106R/P,-665 (Differential Adhesion)	48
DC-4414W,-4420,-4420LB,-4425AR (PVC)	45
DC-5215,-5225,-5227X,-5230X (Cloth)	52
DC-4608MF,-4623MF (Scrim)	53
DC-PEF03A/R,-PEF06A/R,-PEF12A/R,-PEF06P,-PEF12P	59-60
DC-UHB25,-UHB45,-UHB60,-UHB80	57
DE5x6,DE6x8	64
DVT-76Y	11
EC/ET/EX-xxx (Dispensers)	64-73
EL7-xxx, EL75-66AW	6
ENV-Cxxx,-lxxx,-Pxxx	64
EPT-38	10
FA-UHB10B/C,16E/W,20C,25E/W,31E,40C,45E/W,60E/C,80E/W,120W	54-56
FCT-665	5
FIL-795,-825,-890,-930P,-835B/D	29
GC-SH7,-SA7	42
GPM-63	15
HTM-816	15
HOOK & LOOP	27
INV-20M,INV-20M-1	27
KFT-530,KFT-PM2	16
KPT-1,KPT-2	43
LDPE-5AE,-5A,-5R,-7R,-7R/UV,-9R	12-13
LF-5A,LF-5R	39
LP-16AW,LP-20CC	26
MAG03-I/-I0,MAG06-I/-I0,MAG03WO/WOE	31
MMYP-1	44
MYP-25CA/CS,-3US/RS,-36GS/US/OS,-571PS	40-41
NST-20,-20BY,-20C,-20F,-20GL,-20GS,-624B,-NST-B	14
OPP-16AW,-18AW,-20AW,-26AW,-32AW,-P	20-21,26,30
OPP-18,-20,-26NR	24
OPP-16HM,-18HM	24
OPP-20A,-22A,-26A,-34A	22
OPP-20C,-22C,-26C,-26CAW,-P	23,30
OPP-22CC,-26CC,-34CC	21
PES-32G	24
PGD-6,-10,-24,-24HDP	35
PGM-UV14	17
PP20 (Imprinted Legends)	18
PP-500,-800,-4298,-5101	28
PRE-MASK	17
PTFE-35S,PTFE-35H	12
PWT-10C,-10G,-10H,-20C	7
REF-5,-7,-3S,-5S,-DOT,-5DB,-10DB,-DBF	32-34
SBW-80,-120,SFW-80,-80EH,-100,-120,MSW-75	30
SF-VFLD,MD	58-59
SPP-20HTW-1,20RW-B,20HTW,20HT-D	27
SST-618,-636,-718,-718L,-736,-736L,-918L,-936L	10-11
TEV-ST,-OVR	17
TFE-xx,TFES-xx	42-43
TR-7502,-7502X,-7901,-7505	62-63
T-TAK™	61
UHMW-3A,-5A,-10A,-15A,-20A	44
UPVC-22BS,-24BS,-22,-24,-24C,-25F,-P	25-26,30
WAT-WAE	73



# A Complete Line of High Quality, Pressure Sensitive Adhesive Tape